

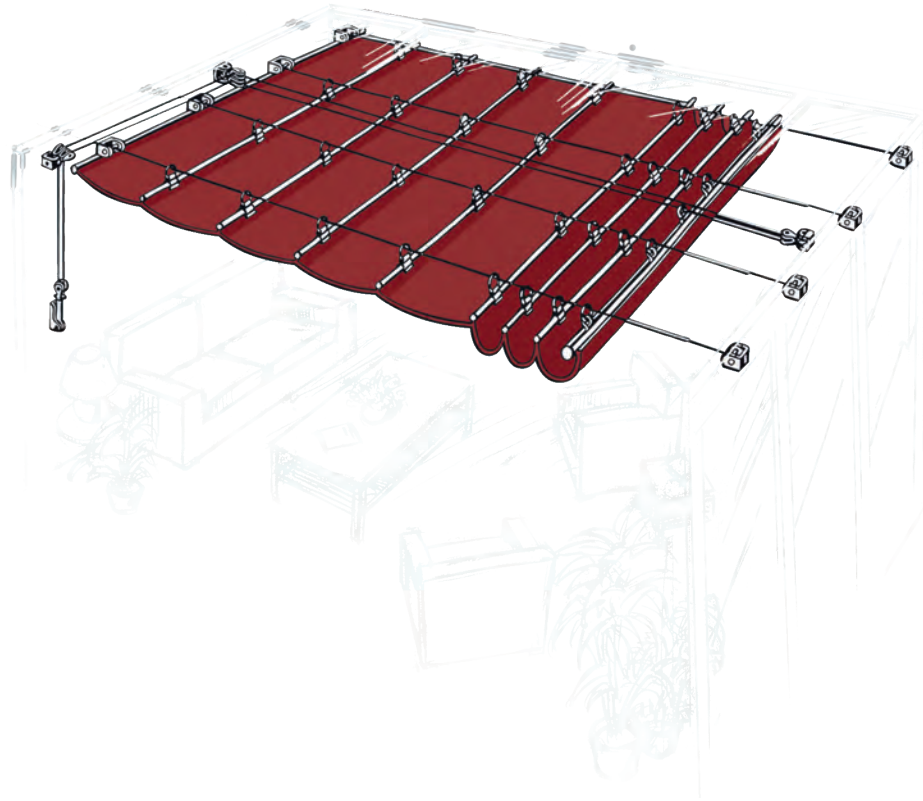

markilux Roof Festoon

**Brings functional airiness and a homely atmosphere
to interior shading**



Design Features

the roof festoon effect creates a cosy atmosphere

Technical Specification

even large, indoor areas can be shaded – easily and simply

Trevira CS fabric permeable to air and resistant to heat (permanently flame-retardant according to DIN 4102 B1, M1 Non Feu (B+F), Classe 1 (I), BS 5867 (GB), EN 13772)

easy operation with manual cord pulley system up to a pitch of 20°

systems up to 100 cm in width and horizontally installed are also available with operating rod

stainless steel tension wires made of polished steel wire

Dimensions and configuration options

		width						
		100 ¹⁾	150	200	250	300	350	400
		100	101 150	151 200	201 250	251 300	301 350	351 400
no. of wires		2	3	3	4	4	5	5
extension	94							
	140							
	188							
	234							
	282							
	328							
	376							
	422							
	470							
	516							
564								
610							—	

1) instead of a cord pulley system, also available with a hooked operating rod (operation by hooked rod only possible when fitted horizontally) dimensions in cm

Operation / Drive unit

	standard	optional
cord pulley system	<input checked="" type="checkbox"/>	—
operating rod	—	<input checked="" type="checkbox"/>

Frame colours

		standard	optional
traffic white	RAL 9016	<input type="checkbox"/>	
metallic aluminium	RAL 9006	<input type="checkbox"/>	
grey brown, similar to	RAL 8019	<input type="checkbox"/>	

Covers

	fabric range no.	standard	optional
sunsilk snc	324 xx / 328 xx / 369 xx	—	<input checked="" type="checkbox"/>
sunvas snc	310 xx / 311 xx 313 xx — 315 xx	—	<input checked="" type="checkbox"/>
Trevira CS	317 xx	<input checked="" type="checkbox"/>	

Colours similar to those in the RAL chart. Colours may differ slightly from those depicted in both hue and finish.

Roof festoon cover sizes

	width	extension
roof festoon cover width = room width	— 60 mm	
roof festoon cover length	—	on request

Additional Information

The width of the roof festoon cover is always **less** than that of the roof festoon.

Depth of the material when retracted:

- up to an extension of 234 cm = approximately 18 cm
- up to an extension of 422 cm = approximately 26 cm
- up to an extension of 610 cm = approximately 36 cm

The roof festoon will work perfectly well up to an angle of 20°.

Intermediate widths and extensions can be supplied.

Trevira CS



161 81

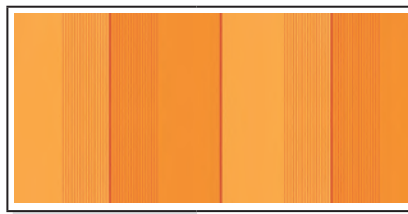

161 82

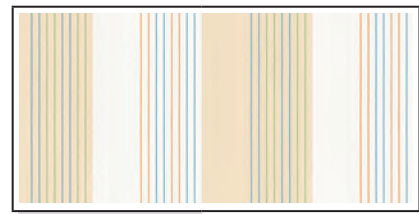

207 87

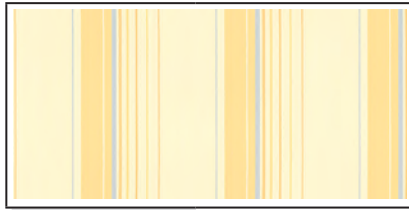

208 01

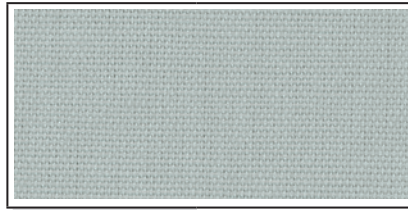

117 08

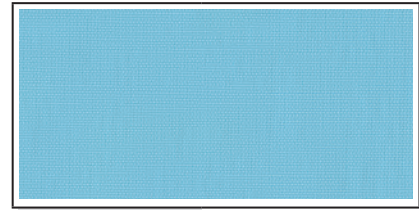

117 10

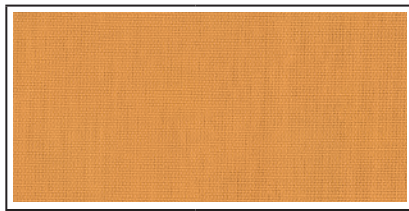

117 11



117 16

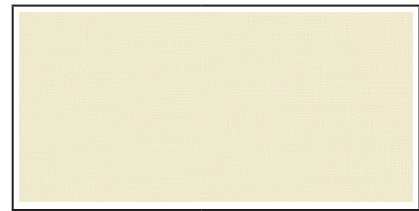

117 32





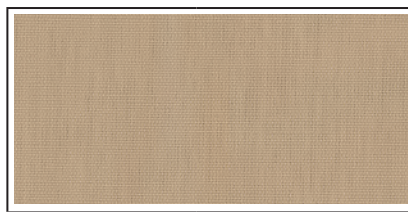

117 41



117 97

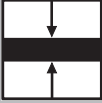

117 71

Fabric pattern		 KG	 Colour and lightfastness (marks 1—8: 8 = very good)	Material	 Permanently, highly flame retardant
161 81 161 82	0.35 mm	185 g/m ²	6	100% Polyester (Trevira CS)	DIN 4102-B1 M1 Non Feu (B+F) Classe 1 (I) BS 5867 (GB) EN 13772
207 87 208 01	0.45 mm	260 g/m ²	6	100% Polyester (Trevira CS)	DIN 4102-B1 M1 Non Feu (B+F) Classe 1 (I) BS 5867 (GB) EN 13772
117 08 117 10 117 11 117 16 117 32 117 41 117 71 117 97	0.35 mm	185 g/m ²	6	100% Polyester (Trevira CS)	DIN 4102-B1 M1 Non Feu (B+F) Classe 1 (I) BS 5867 (GB) EN 13772

How to measure up for a markilux roof festoon

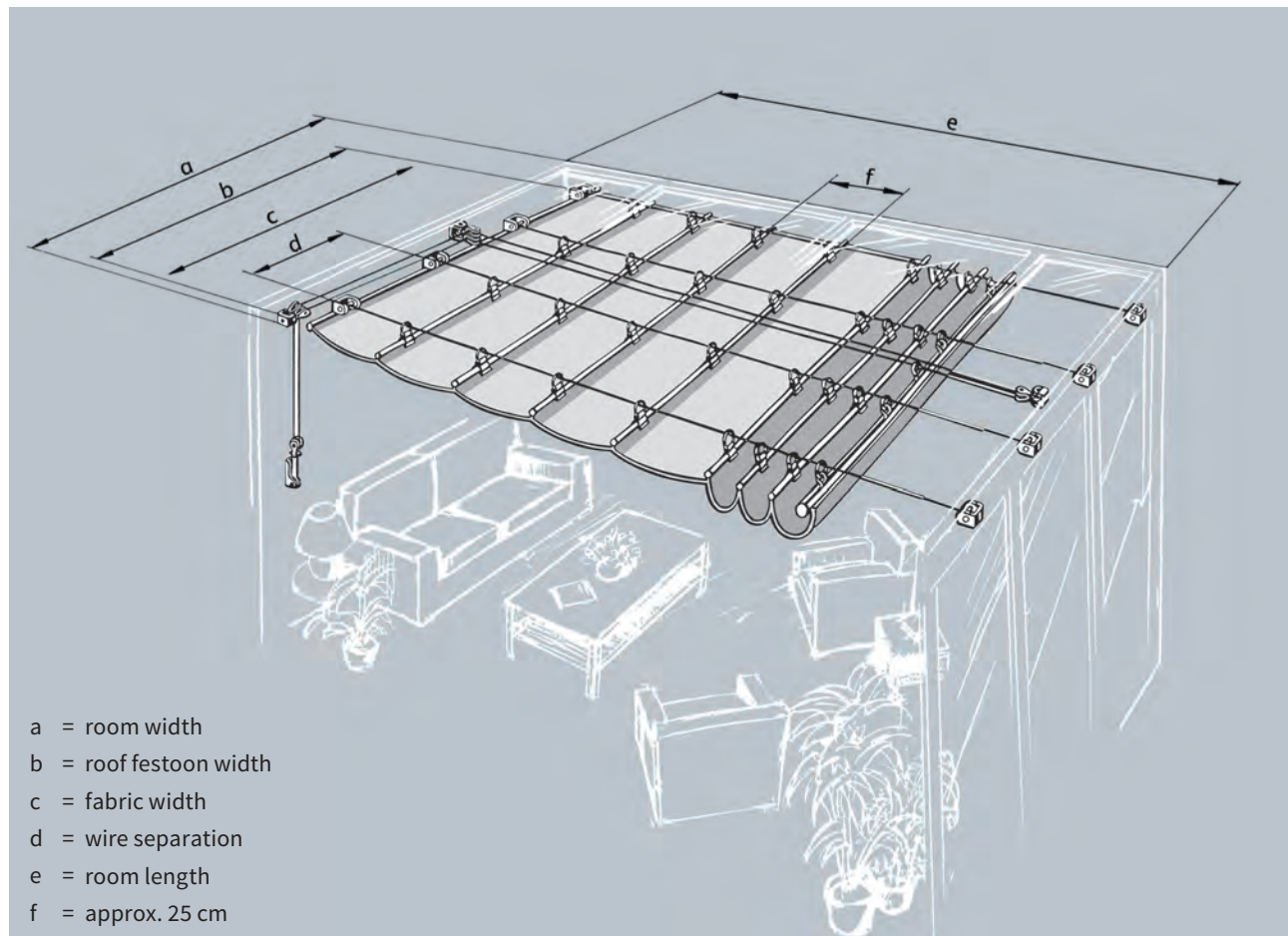

Start by determining the length and breadth of the room. Obstacles such as light fittings, beams, protruding pieces of wall, air ducts etc. should be taken into account. markilux roof festoons can only be rectangular in shape. To arrive at the roof festoon width, subtract 6 cm from the width of the room. The outermost wire on each side is positioned approximately 3 cm from the edge of the material.

The distance between the wires can be set individually, but they have to run absolutely parallel to one other and to the edge of the roof festoon. The maximum wire separation may not exceed 100 cm. We recommend you plan to fit the roof festoon below beams, purlins etc. The minimum number of wires required for each particular width is laid down in the table shown. Additional wires can be supplied on request (surcharge). The cover is stitched together from panels of material which run contrary to the direction of extension of the roof festoon.

A seam separation of approximately 25 cm results in a collapsed fabric height of approximately 16 cm when the roof festoon is retracted.

Please be sure to notify us if a number of roof festoons are to be hung next to one another.

Solar shading systems made of textile material can stretch. When roof festoons are hung next to one another, we cannot guarantee that the seams will always match up perfectly. It is not possible to get the pattern of striped materials to match one another in two separate roof festoons. Please use plain fabrics.

Tolerances of around 1% must be expected where textiles are concerned.

When ordering, the following measurements and information will be required:

- roof festoon width (room width minus 6 cm)
- extension (room length)
- fabric pattern no.
- fixture brackets and front profile can be supplied
- optionally in the standard colours traffic white, grey brown or metallic aluminium
- fixing brackets and front profile
- any additional wires, if required
- fixture type (face or top fixture)

Installation dimensions

Top fixture in the case of cord pulley operation (top fixture bracket assembly, part no. 79199.)

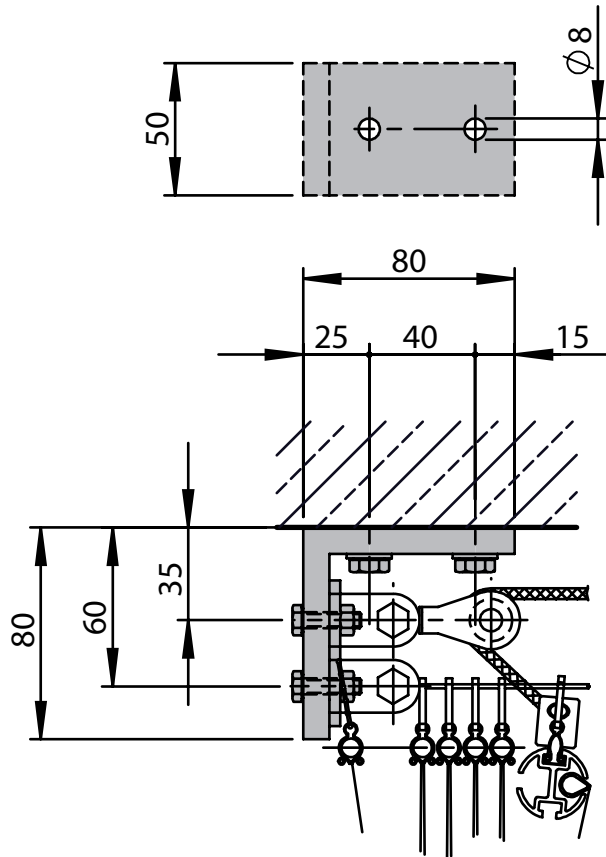

Face fixture with cord pulley system

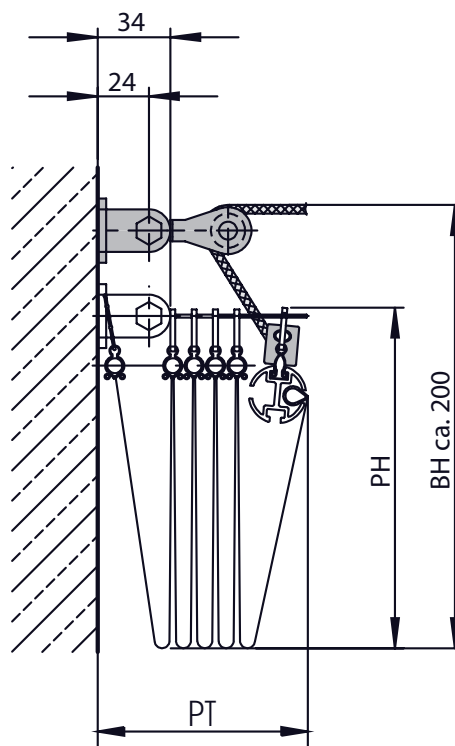

PH = fabric height closed

BH = overall fixture height

PT = depth of retracted material