



markilux Optional Accessories

markilux Infrared heater

Cosy warmth when it starts to get cool



- radio remote control is possible with the Heat Receiver RTS using 433 MHz technology and with an external receiver in 868 MHz technology
- easy, variable fixture to any wall
- the heater direction can be adjusted via the fixture bracket
- wired to the mains by means of a connecting plug (Hirschmann)
- save at least 30% on energy costs in comparison with gas or quartz radiating heaters
- lamp life approximately 5,000 hours
- for the best results it should be fitted at a height of approx. 2 m
- order no. 8600220

- feel the warmth in an instant and enjoy more of the evening outside
- caressing warmth with no warming up phase and a pleasing lighting effect at the same time
- warms people and not the air
- creates noticeable warmth in the enclosed space under the awning within an area of approx. 9 to 12 m²
- the attractively designed, unobtrusive housing in aluminium is powder coated to match that of your markilux awning – non-standard RAL colours incur a surcharge
- the housing is weather and splash proof – the heater can stay in place all year round

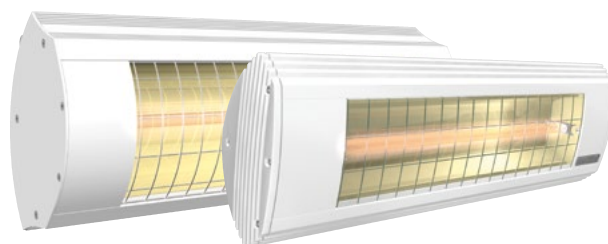

Infra-red Technology

PHILIPS HeLeN

Technical specification

power supply	230 V, 50 Hz, slow fuse 16 A fuse (class C)	
wiring cross section	H05SS 3 × 1.5 mm ²	
power output (per infrared heater)	1400 W	2000 W
length × depth × height (mm)	460 × 145 × 75	445 × 175 × 111
weight (kg)	approx. 1.8	approx. 3.1

Effectiveness of the infrared heater

	Effectiveness				
	at the maximum fixture height	1400 W		2000 W	
		2.25 m	2.50 m		
	Face fixture (optimum angle of inclination 20°)		Top fixture		
Wind strength	1400 W	2000 W	1400 W	2000 W	
no wind (< 0.2 m/s)	100 %	100 %	100 %	100 %	
moderate breeze (< 2.0 m/s)	69 %	78 %	65 %	89 %	
strong breeze (< 4.0 m/s)	44 %	51 %	37 %	54 %	

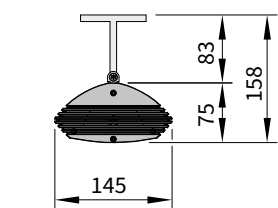
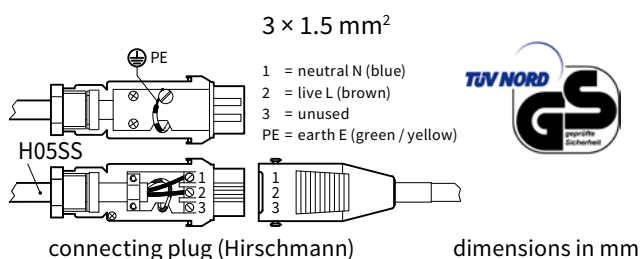

side view
infrared heater 1400 W

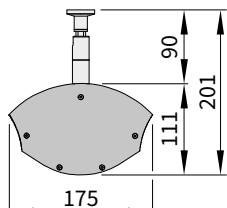

side view
infrared heater 2000 W

Housing colours

		standard	optional
traffic white	RAL 9016		
metallic aluminium	RAL 9006		
off-white textured finish	5233		
stone grey metallic	5215		
anthracite metallic	5204		
Havana brown textured finish	5229		
grey brown, similar to	RAL 8019		
non-standard powder-coated finish			

Colours similar to those in the RAL chart. Colours may differ slightly from those depicted in both hue and finish.

markilux hotspot

Warmth and light in stylish combination

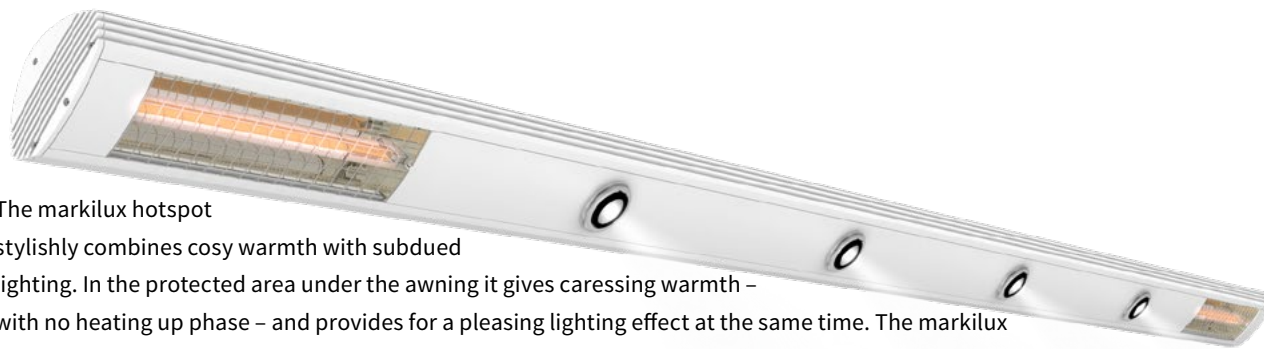

The markilux hotspot stylishly combines cosy warmth with subdued lighting. In the protected area under the awning it gives caressing warmth – with no heating up phase – and provides for a pleasing lighting effect at the same time. The markilux hotspot can be fitted at any time – even at a later date – directly to the wall or soffit. It can be adjusted within a maximum range of 30° to each side. The built-in spotlights can be adjusted individually – they can be rotated through 360° and tilted up to 60°.

The attractively designed, unobtrusive housing in aluminium is powder coated to match that of your markilux awning – non-standard RAL colours incur a surcharge. The markilux hotspot is controlled via an On/Off switch. It is wired to the mains by means of a connecting plug (Hirschmann).

Order no. 8600309 traffic white (RAL 9016)

Order no. 8600308 metallic aluminium (RAL 9006)

Order no. 8600349 in a non-standard powder-coated finish

Technical specification

power supply	230 V, 50 Hz, slow 16 A fuse (class C)
protection level / protection class	IP24 / I
wiring cross section	H05SS-F 5G 5 × 1.5 mm ²
power output (infrared heater)	2 × 1400 Watts
power output (spotlight)	4 × 20 Watts
no. of fixture brackets	3
length × depth × height (mm)	300 × 145 × 73
weight (kg)	12.2

Effectiveness of the infra-red heater

Wind strength	Effectiveness (at the max. fixture height of 2.25 m)	
	Face fixture (optimum inclination angle 20°)	Top fixture
no wind (< 0.2 m/s)	100 %	100 %
moderate breeze (< 2.0 m/s)	69 %	65 %
strong breeze (< 4.0 m/s)	44 %	37 %

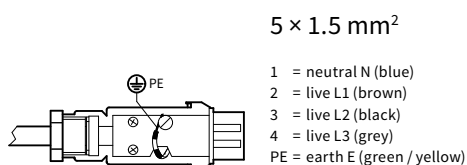

connecting plug (Hirschmann)

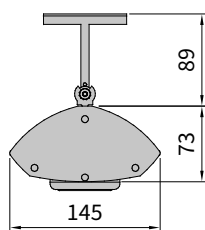

side view with a turn and tilt bracket

dimensions in mm

Housing colours

		standard	optional
traffic white	RAL 9016		
metallic aluminium	RAL 9006		
non-standard powder-coated finish			

Colours similar to those in the RAL chart. Colours may differ slightly from those depicted in both hue and finish.

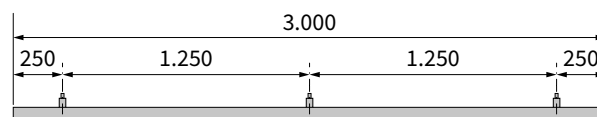

4 spotlights with 2 infrared heaters, bracket quantity and distribution

01
02
03
04
05
06
07
08
09
10
11
12
13
14
15
16
17
18
19
20
21

markilux spotlight

The unobtrusive lighting bar



With the markilux spotlight the area underneath the awning is bathed evenly in a pleasant light.

The markilux spotlight with turn/tilt joint can also be retrofitted to the wall or ceiling. The built-in spotlights can be adjusted individually – they can be rotated through 360° and tilted by up to 60°.

The attractively designed, unobtrusive housing in aluminium is powder coated to match that of your markilux awning – non-standard RAL colours incur a surcharge.

The markilux spotlight is controlled via an On/Off switch. It is wired to the mains by means of a connecting plug (Hirschmann).

Order nos. (200 cm with 3 Spots / 300 cm with 5 Spots):

Order no. 8600267 / 8600279 traffic white (RAL 9016)

order no. 8600266 / 8600278 metallic aluminium (RAL 9006)

Order no. 8600352 / 8600354 in non-standard powder-coated finish

Technical specification

power supply	230 V, 50 Hz	
protection level / protection class	IP44 / I	
wiring cross section	H05RN-F 3G 3 × 1.0 mm ²	
power output (per spotlight)	20 Watt	
length (mm)	89 × 40	
no. of spotlights	3	5
weight (kg)	2.8	4.4

Housing colours

		standard	optional
traffic white	RAL 9016		
metallic aluminium	RAL 9006		
non-standard powder-coated finish			

Colours similar to those in the RAL chart. Colours may differ slightly from those depicted in both hue and finish.

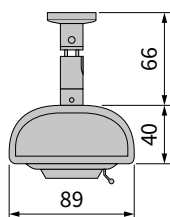
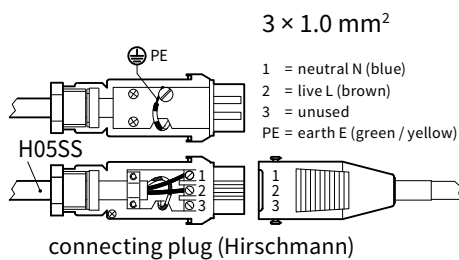

side view

dimensions in mm

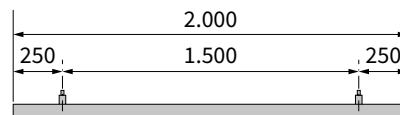

3 spotlights

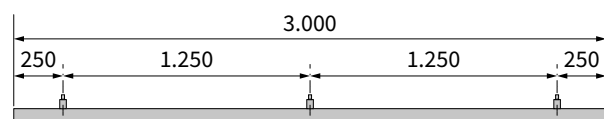

5 spotlights

quantity of brackets and their separation from one another

Stainless steel winding handle

quality to get to grips with

The markilux stainless steel winding handle that is supplied with gearbox-operated awnings, combines timeless elegance and quality that can be felt. When using the winding handle you can feel its quality by virtue of the virtually silent bearings and ergonomic design.



Winding handle lengths:

- 110 cm
- 140 cm
- 160 cm
- 180 cm
- 220 cm

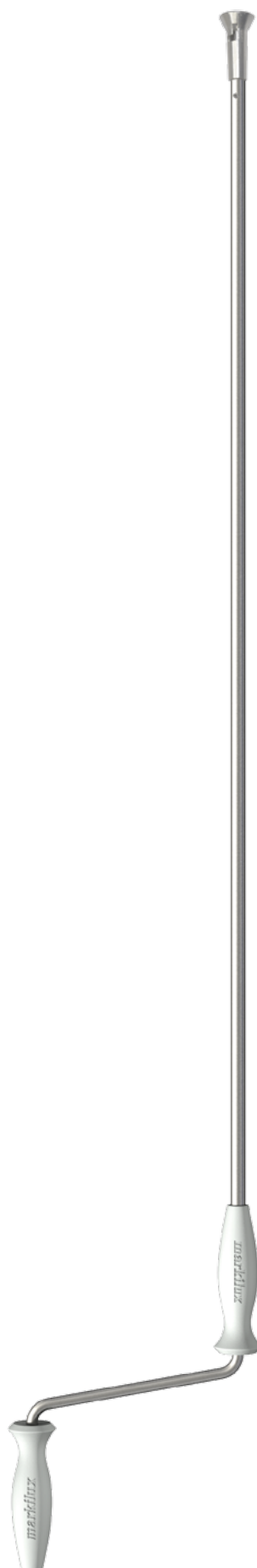

01

02

03

04

05

06

07

08

09

10

11

12

13

14

15

16

17

18

19

20

21

Signwriting on covers and valances

Valances and awning covers offer an ideal area to display your advertising or sponsoring.

Apart from bespoke printing options, three standard printing processes are available:

- **stencil printing**
- **thermo-transfer printing**
- **digital printing**

Please send us your signwriting or logo.

We will be pleased to make you an individual offer for both colour and / or monochrome printing.

**1. Stencil printing (for valances and covers):**

- high quality and durable textile signwriting for large valances and covers
- extremely durable – three applications of colour
- very good light fastness and resistance to UV (light fastness 7–8)
- the signwriting is applied manually using several hand-made stencils
- all the fonts offered by Microsoft Word are available

2. Thermo-transfer printing (only for valances):

- the less expensive alternative for smaller budgets and short to medium term advertising campaigns
- the signwriting is applied using a thermal transfer process
- limited light fastness
- less durable than the stencil process

3. Digital printing (for large areas and covers):

- the new printing technique offering unlimited possibilities
- ideal for large areas and detailed images
- realistic representation of logos and photos: just about anything is possible
- digital files must be submitted in PDF/X-3 or TIFF format, other formats may be possible so please ask us
- optimum printing quality at a resolution of at least 70–100 dpi
- printed on white awning fabric or on request on Soltis material
- we recommend that the un-printed white edges, which appear as a result of discrepancies between the size of the picture and the cover, be filled with a plain colour

markilux silentec

Innovative motor noise reduction technology: amazingly quiet. Make using your markilux 8800 even more pleasurable



By acoustically insulating the motor, it becomes astonishingly quiet. It is also possible to operate the markilux silentec motor via radio-control (optional) by using an external Universal Slim Receiver RTS plug (order no. 8272148).

Only single awnings or single fields (refer to the matrix for units with two folding arms or one field) can be fitted with the silentec motor.

For configuration options such as “Dimensions and optional accessories” please consult the section pertaining to the individual markilux models.

markilux silentec cannot be retro-fitted to existing awnings.

markilux PVC foil windows



Awning covers with PVC foil windows

We offer awning covers with integrated PVC windows for vertical blinds with tensioning system. The basic material used for the window is a transparent UV-resistant PVC film.

Window	Dimensions (mm)
maximum height	2000
maximum width	1070

The maximum quantity of windows per cover can be deduced from the cover width and the number of full panel widths. Windows are only inserted into full panel widths. The windows can be incorporated only in complete fabric panels.

Position	Minimum dimensions (mm)
top / bottom	250
from the side to seam centre	50
between windows	100

The awning cover must be made of sunsilk or sunvas material, stitched or bonded together in panels (no widely woven fabrics).

The window panels must be arranged symmetrically!

Important note:

Because different materials are being joined this can lead to differences in tension between the two materials which may cause winding creases and puckering near the seams.

Moisture on the foil can lead to a change in the chemical properties of the plasticising agent, which may lead to the foil becoming cloudy. The influence of heat and rolling the material up when damp may exacerbate this effect. Consequently it is to be recommended that any moisture on the foil be allowed to evaporate before the blind is retracted. Given time the cloudiness in the foil may disappear again. However, because of wide variations in climate conditions, no guarantees can be given in this regard.

Please inform your customers that it is not possible – given current technology – to prevent this phenomenon occurring and that it is no cause for complaint.

Dimensional overviews of markilux PVC foil windows

Overview of the dimensions of a standard window

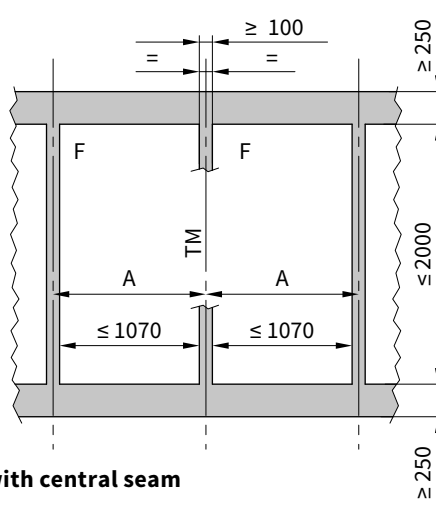

Overview of the dimensions of a cover with central seam

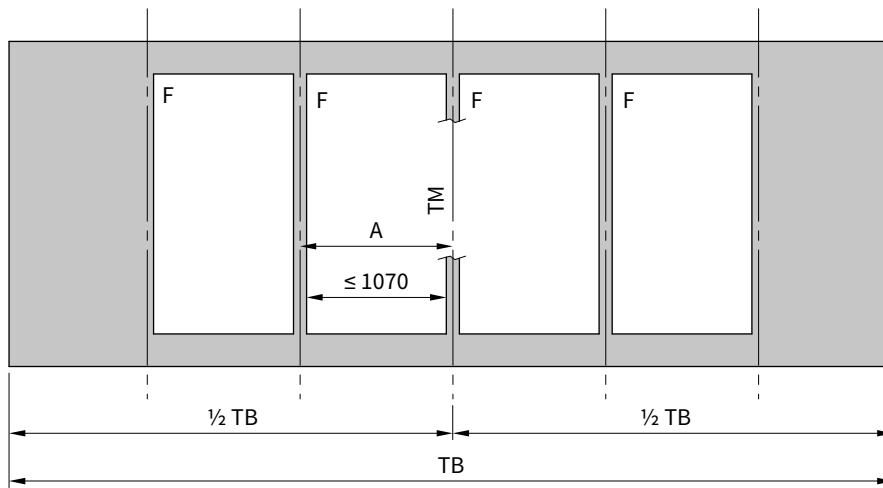

Overview of the dimensions of a cover with central panel

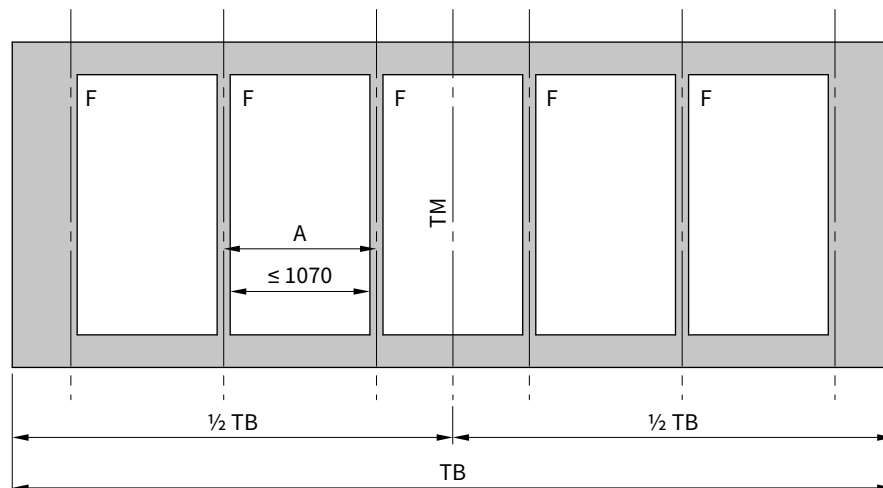

TB = cover width

TM = centre line of the cover

A = distance from centre seam to centre seam

F = PVC window

≤ = smaller or equal to

≥ = larger or equal to

dimensions in mm

Automatic controls, switches, accessories



Light and wind sensor Soliris Uno

Depending on the prevailing conditions with regard to the wind and sun a single markilux awning will be extended or retracted. The wind speed and lux value required to do this is set directly via the sensor. There is a sliding switch which can quite simply deactivate the sun sensor. The awning can then be controlled manually.

Order number 8272081



Light and wind sensor Soliris IB

In accordance with the prevailing wind and sun conditions, several markilux awnings will be extended or retracted. The wind speed and lux values required to do this are set directly via the sensor. There is a sliding switch which deactivates the sun sensor if required. The Soliris IB is designed to work with a group control unit (each drive unit requires an additional motor control mechanism Centralis Uno IB), whereby each individual control mechanism is connected to a bus system (IB Bus).

Order number 8272082



Rain Sensor Ondeis 230 V AC

for the light and wind sensor Soliris Uno or Soliris IB

Electrically powered sensor, which uses two non-corroding sensing electrodes to detect rain and snow. The rain sensor must be connected to the pre-installed light and wind sensor Soliris Uno or Soliris IB.

Order number 8272065



Individual motor control mechanism Centralis Uno IB (small group control mechanism)

A motor control mechanism Centralis Uno IB is required for every drive unit that is to be controlled. The sliding switch makes it quite simple to remove an awning from the central control system. Individual operation is therefore possible at any time. 2 intermediate positions can be programmed. Warning signals are sent to a LED display (e.g. awning disabled because of excessive wind levels).

Order number 8272085



Surface fixture switch frame

Frame for surface fixture switch (switch is not included), single, Jung LS 981 A WW, for the installation of surface fixture switches only in combination with the Soliris Uno, Soliris IB and Centralis Uno IB.

dimensions approx. 78 × 78 × 40 mm (L × B × H)

Order number 8272027, alpine white



Cut-off relay TR4-AP-230

Cut-off relay (230 V, 50 Hz), for surface fixture, for the control of up to 4 motor drives with mechanical or electronic limit switching. The cut-off relay prevents the motor drives from being linked in parallel, which is not permitted.

Order number 8272187



Somfy universal set-up switch

For the setting-up of 230 V motors, for RTS or WT motors and also for Becker and Elero motors.

Order number 8271084

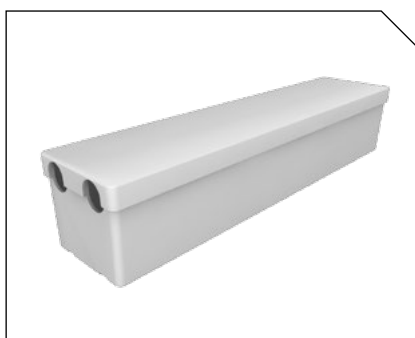

Protective box for connecting plug (Hirschmann)

Protective box to tidy away the awning connecting plug near the awning. dimensions 45 × 35 × 175 mm (width × depth × height)

Order number 8271044, white

Order number 8271043, black

Order number 8271045, light grey

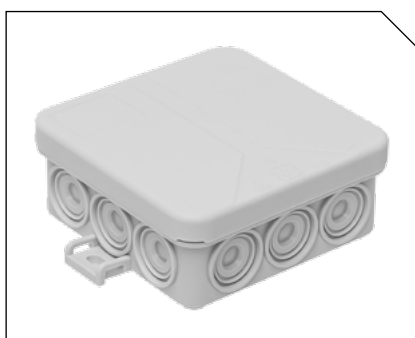

Junction box for the markilux E-box

Protection class IP 55, 12 sealed access points dimensions 85 × 85 × 37 mm (width × depth × length)

Order no. 8271177, light grey

Power cable, 5 metres long for hard-wired motors

The power supply cable is pre-installed in the factory and is always fitted with a connecting plug (Hirschmann) for reasons of health and safety.

Order number 8271067 Elero motor drives

Order number 8271115 Becker motor drives

Radio Controls 433 MHz



markilux Hand-held remote control (1 channel)

The markilux Hand-held remote control (1 channel) allows you to operate your awning comfortably at the touch of a button. The attractive shape and ergonomic design characterise this elegant and easily operated hand-held remote control.

Order number 8272130



markilux hand-held remote control (4 channel)

This markilux radio remote control (4 channel) allows you to control the awning itself as well as the light and wind function and the dimmer function on awnings with lighting at the touch of a button. The attractive shape and ergonomic design characterise this elegant and easily operated hand-held remote control.

Order number 8272131

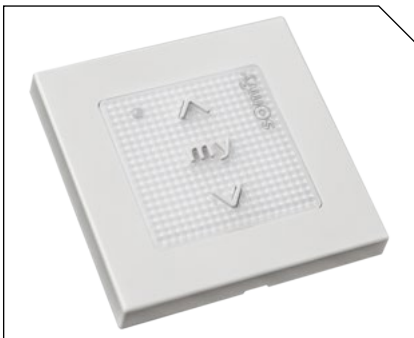

markilux radio control wall switch Smoove Pure Shine (1 channel)

Easy blind or awning control using the sensitive radio control wall switch Smoove Pure Shine (1 channel). Also has an additional "my" function to set your favourite awning position automatically.

with pressure switches incl. frame

Order number 8272235



Radio controlled light and wind sensor Soliris Sensor for RTS motors

Depending on the prevailing wind and sun conditions the awning or awnings are extended or retracted. The values for the wind and lux sensors are set via the central control unit. The Soliris Sensor RTS transmits the signals by radio wave. This does away with all the wiring to the central control unit and the motor drive. The sun sensor can be manually activated or deactivated by means of a remote control.

Order number 8272089



Radio controlled light and wind sensor Soliris Sensor for RTS motors with a connection for a rain sensor

Depending on the prevailing wind and sun conditions the awning or awnings are extended or retracted. The values for the wind and lux sensors are set via the central control unit. In combination with a suitable rain sensor (order no. 8272065) the awning will retract if it starts to rain. The Soliris Sensor RTS transmits the signals by radio wave. This does away with all the wiring to the central control unit and the motor drive. The sun sensor can be manually activated or deactivated by means of a remote control.

Order number 8272127



Rain Sensor Ondeis 230 V AC

for a radio control light and wind sensor with rain sensor connection

- the presence of rain and snow is measured by way of a capacitor (maintenance free)
- quick, reliable sensor reaction due to the accurate measurement of precipitation
- integrated, self-regulating heater
- quick and problem-free fixture
- easily installed (both contact cables are white, two core and UV stable)

Order number 8272065



Radio control wind sensor Eolis Sensor RTS

Keeps a constant eye on the wind speed: as soon as the individually pre-set value is exceeded, the sensor retracts the awning. Radio controlled operation makes wiring between the operating point and the motor drive unnecessary. Only a 230 V power supply cable is required.

Order number 8272090



Radio control light sensor Sunis WireFree RTS

Solar cell operated light sensor – which can be fitted anywhere on the façade.

For awnings with 433 MHz RTS motors, does not need to be wired into the mains. Built-in solar cells supply the unit with power. Up to three Sunis light sensors can be linked to any one radio-controlled motor. But one Sunis light sensor can also operate a number of radio-controlled motors.

Order number 8272141



markilux Vibrabox

The markilux Vibrabox, the sensor for dynamic wind loads is sensitive to vibration. It can be fixed to the inside or outside of the front profile (depending on the awning model) without requiring a power supply cable. Different levels of sensitivity can be selected. Battery powered, so no power supply or cabling required.

Order number 8272140 anthracite

Order number 8272144 white

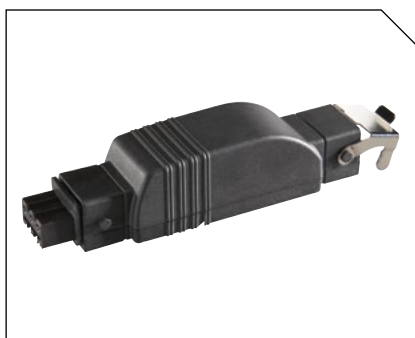

External radio control receiver Universal Slim Receiver RTS Plug as an in-line solution

The easy way to automate an awning with standard motor or provide an automatic radio-controlled option (light, wind, rain sensor) at a later date. Quick and easy installation between the motor and the power supply cables (via a Hirschmann connecting plug). The following is then possible:

- individual operation, i.e. a single radio remote control operates a single receiver
- group operation, i.e. a single radio remote control operates more than one receiver (e.g. motor)
- multiple operation, i.e. more than one radio remote control operates a single receiver

Order number 8272148

Radio Controls 433 MHz

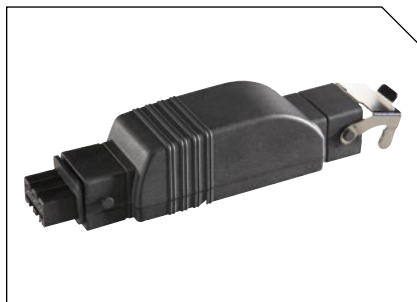

External radio receiver Heating Slim Receiver RTS Plug for infrared heater

The external receiver for the infrared heater. Quick and easy installation between the motor and the power supply cables (via the Hirschmann connecting plug). The following is then possible:

- individual operation, i.e. a single radio remote control operates a single receiver
- group operation, i.e. a single radio remote control operates more than one receiver
- multiple operation, i.e. more than one radio remote control operates a single receiver

Order number 8272138



External radio receiver Heating Mod/Var Receiver RTS for infrared heater

The dimmable external receiver for the infrared heater. The power output to the heater can be regulated in three stages: 33%, 66% and 100%.

Order number 8272227



External radio-controlled receiver Centralis Indoor RTS, for awnings with lighting

The external lighting receiver for internal installation in a flush-fitted wall box, with a diameter of 60 mm, without dimmer function.

Order number 8272102

io Radio controls



Radio control handset Situo mobile io (1 channel)

The attractive, hand-held remote control Situo mobile io (1 channel) allows easy control of one or several blinds or awnings, equipped with a motor in io technology. Also has an additional “my” function to set your favourite awning position automatically. The Situo mobile io can also be used as a wall-fixed remote control.

Order number 8272188



Radio controlled handset sunshade control Easy Sun io

Up to 15 products in five product groups can be controlled by the Easy Sun io. Equipped with additional memory function “my” to set your favourite awning position automatically, an auto/manual function as well as allowing the lux and wind thresholds to be individually set. The executed commands can be checked via the display and via LED.

Order number 8272191



Radio control wallset Smoove io Pure shine (1 channel)

Easy blind or awning control using the sensitive radio control wall switch Smoove Pure Shine (1 channel). Also has an additional “my” function to set your favourite awning position automatically.

Order number 8272189



Radio control wallset Smoove A/M io Pure shine (1 channel)

Easy blind or awning control using the sensitive radio control wall switch Smoove Pure Shine (1 channel). Also has an additional “my” function to set your favourite awning position automatically as well as the option to switch from auto to manual.

Order number 8272190



Radio control wind sensor Eolis WireFree io

The battery-powered radio controlled wind sensor Eolis WireFree io can be fitted directly to the façade without the need to lay any annoying cabling. The wind threshold value can be set individually directly via the sensor or via the radio control façade unit Easy Sun io in combination with the Sensor Box io.

Order number 8272193 white

01

02

03

04

05

06

07

08

09

10

11

12

13

14

15

16

17

18

19

20

21

io Radio controls



markilux Vibrabox Eolis 3D WireFree io

The markilux vibrabox Eolis 3D WireFree io, the sensor for dynamic wind loads reacts to vibration. It can be fixed to the inside or outside of the front profile (depending on the awning model) without requiring a power supply cable. The wind threshold value can be set individually directly via the sensor. Battery powered, so no power supply or cabling required.

Order number 8272197, traffic white (RAL 9016)

Order number 8272198, traffic grey (RAL 7043)



Radio control light sensor Sunis WireFree io

The battery-powered radio control light sensor Sunis WireFree io can be mounted directly to the façade without any annoying cables. The light threshold value can be set individually via the radio control façade unit Easy Sun io in combination with the Sensor Box io.

Order number 8272192, white (single unit)

Order number 8272199, white (set with communication unit Sensor Box io)



Communication unit Sensor Box io

Communication unit Sensor Box io, for the exchange of information between sun-shade controls and sensors.

Order number 8272196, white (single unit)

Order number 8272199, white (set with radio control light sensor Sunis WireFree io)



Set: radio control light sensor Sunis WireFree io and

Communication Unit Sensor Box io

The battery-powered radio control light sensor Sunis WireFree io can be mounted directly to the façade without any annoying cables. The light threshold value can be set individually via the radio control façade unit Easy Sun io in combination with the Sensor Box io.

Communication unit Sensor Box io, for the exchange of information between sun-shade controls and sensors.

Order number 8272199 white



External radio receiver Plug Receiver io, as an in-line solution

The external radio Plug Receiver io for the leisurely switching on and off of lamps, radios, TVs and other domestic appliances (not suitable for awning motors).

Order number 8272195 white

markilux E-box

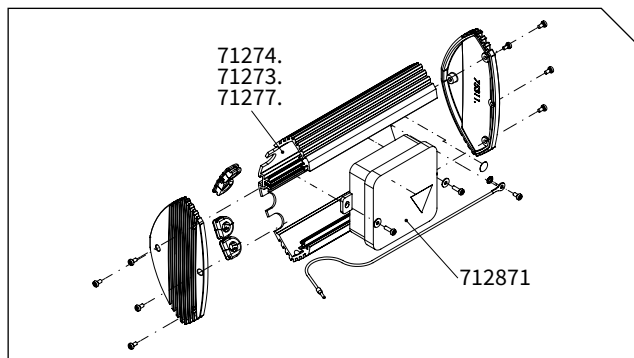

For carrying out electrical installations safely and easily
 Electrical components such as plug connections and junction boxes come to form an aesthetic part of the installation by virtue of the markilux E-box.

The E-box is available in three models:

- **E-box K**
 accepts a single plug connection (e.g. Hirschmann plug). Width = 188 mm
- **E-box M**
 suitable for a plug connection with external receiver or for the installation of an awning with lights and an additional connection for a shadeplus. Width = 378 mm
- **E-box G**
 can be ordered to a bespoke width (BB)

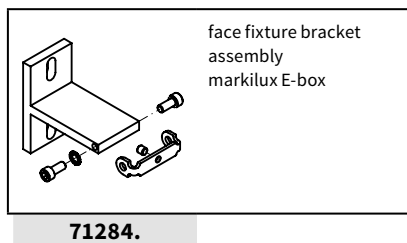
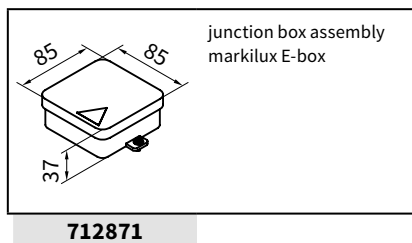
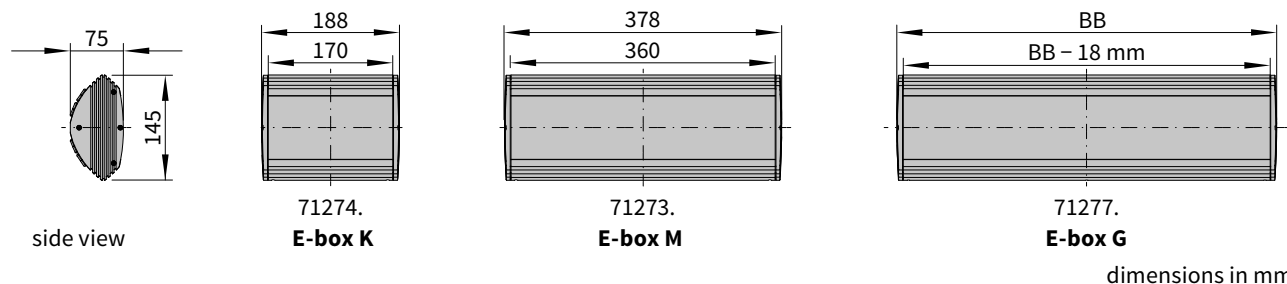

BB = order width (E-box G)
 . = insert RAL colour code no.

01
02
03
04
05
06
07
08
09
10
11
12
13
14
15
16
17
18
19
20
21

Face fixture bracket for the markilux E-box



markilux E-box, face fixture

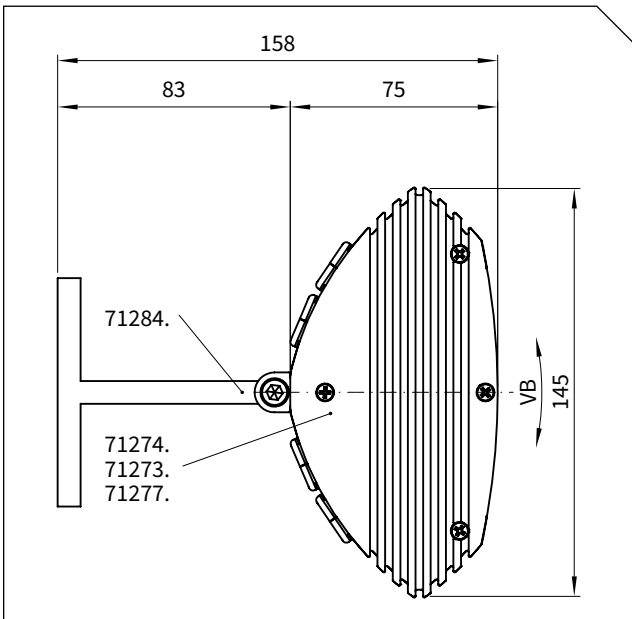
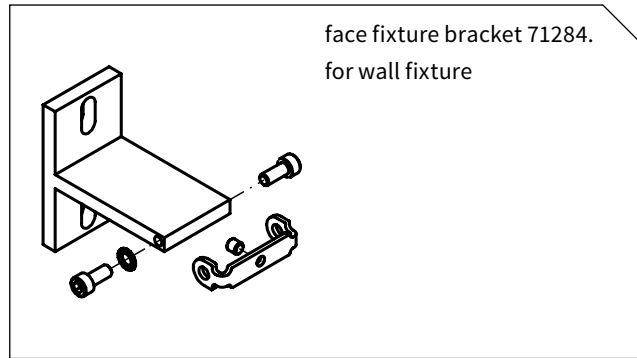

The no. of face fixture brackets required when using different E-box models

E-Box model	No. of face fixture brackets
E-box K	1 pc
E-box M	1 pc
E-box G	1 pc (if length < 0.3 m) / for every additional metre 1 pc extra

VB = adjustment range of the E-box

. = insert RAL colour code no.

dimensions in mm