



## **markilux 3300 pur**

**The cassette awning with wall seal**

**The alternative with smooth front profile**



folding arms with bionic tendon (standard)

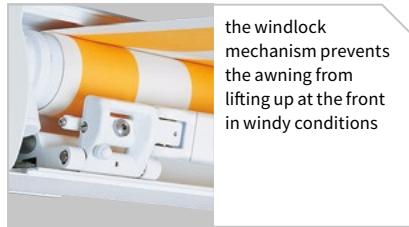

the windlock mechanism prevents the awning from lifting up at the front in windy conditions

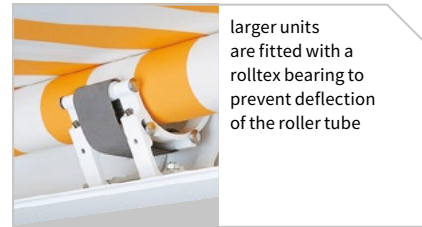

larger units are fitted with a rolltex bearing to prevent deflection of the roller tube

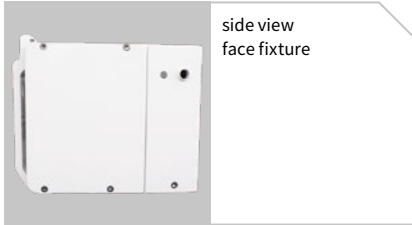

side view face fixture

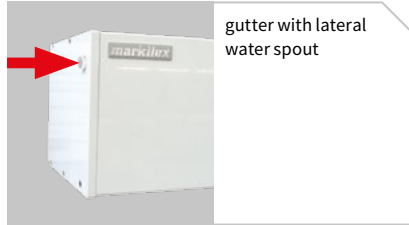

gutter with lateral water spout

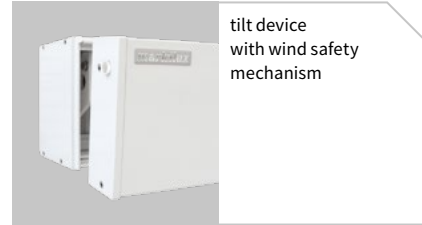

tilt device with wind safety mechanism

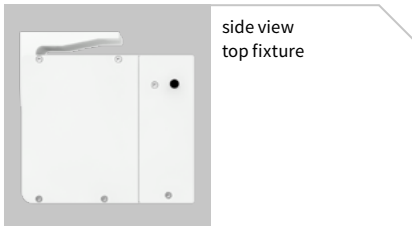

side view top fixture

### Design Features

the sturdy compact cassette with the perfect seal to the wall

elegant and robust front profile made of aluminium

self-supporting cassette made of extruded components

### Technical Specification

when closed the folding arms are protected from the weather by the cassette

the front profile with integrated double gutter ensures that water flows off to the side of the awning whether it is open or closed

the 85 mm roller tube ensures the highest stiffness and the best possible cover winding characteristics even at the largest widths

the extremely sturdy awning construction makes it possible to shade even very large areas safely

unique arm technology with power transference using bionic tendon made of high-tech fibres with extremely high tensile strength. Tested by The Fraunhofer Institute

### Optional Accessories

radio-controlled motor with radio remote control for ease of use

hard-wired motor operation (optionally with automatic weather controls) for straightforward and easy operation

in the case of manual operation ease of use is ensured with the spring-assisted gearbox

awning available in non-standard RAL colours

available with a valance

wall seal using aluminium / rubber sealing strip

awnings with 2 folding arms are available with the innovative silentec technology

## Lounge colours

off-white textured finish

5233

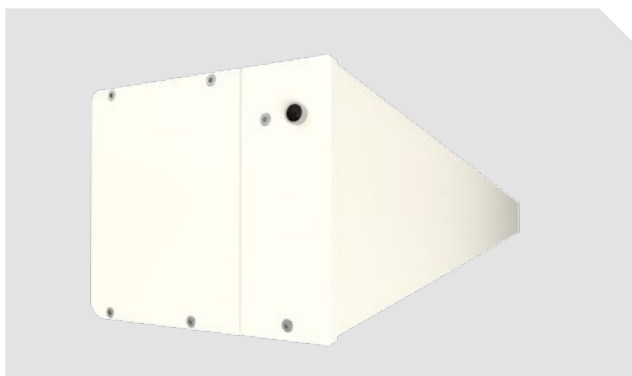

stone grey metallic

5215

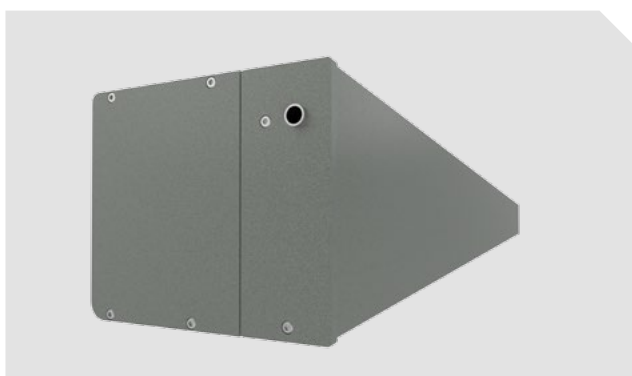

Havana brown textured finish

5229

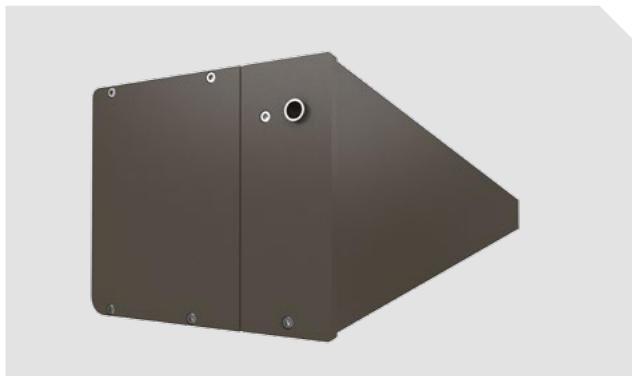

anthracite metallic

5204

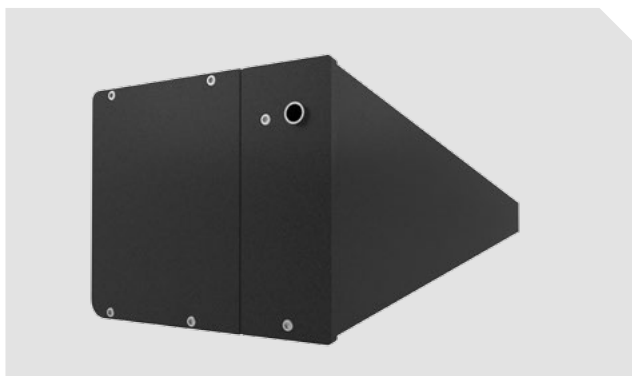

Colours may differ slightly from those depicted in both hue and finish.

- 01
- 02
- 03
- 04
- 05
- 06**
- 07
- 08
- 09
- 10
- 11
- 12
- 13
- 14
- 15
- 16
- 17
- 18
- 19
- 20
- 21
- 22
- 23

### Dimensions and configuration options

		M									M min.					
		250	300	350	400	450	500	550	600	650	700(2)	M			M	
		190 250	251 300	301 350	351 400	401 450	451 500	501 550	551 600	601 650	651 700	⊗	⊗	⊗	⊗	⊗
H	150	3)										203	190	450	203	190
	200	3)	3)									253	240	500	253	240
	250	-	3)	3)								303	290	550	303	290
	300	-	-	3)	3)							353	340	600	353	340
	350 <sup>1)</sup>	-	-	-	3)	3)				1) 2)		403	390	650	403	390

dimensions in cm

  = 
  = 
  =

- 1) no intermediate sizes possible below the standard width of 650 cm
- 2) awnings with 3 arms are only available with motor (surcharge)
- 3) please note the minimum widths!

#### Operation / Drive

	standard	optional
manual operation	<input checked="" type="checkbox"/>	—
servo-assisted operation	—	<input checked="" type="checkbox"/>
hard-wired motor	—	<input checked="" type="checkbox"/>
io radio controls	—	<input checked="" type="checkbox"/>
silentec	—	<input checked="" type="checkbox"/> <sup>4)</sup>
radio-controlled motor (433 MHz)	—	<input checked="" type="checkbox"/>

4) only single units with 2 folding arms

#### Coupled units

	standard	optional
2 fields	—	<input checked="" type="checkbox"/> <sup>5)</sup>
3 fields	—	<input checked="" type="checkbox"/>
junction roller	—	<input checked="" type="checkbox"/> <sup>6)</sup>
one-piece cover	—	<input checked="" type="checkbox"/> <sup>7)</sup>

- 5) minimum widths see „Technical Information“
- 6) see overview „Bracket fixture range“
- 7) up to a maximum awning pitch of 15° and up to a maximum projection of 350 cm; on request

#### Miscellaneous

	standard	optional
bionic tendon	<input checked="" type="checkbox"/>	—
wall seal by way of aluminium + rubber sealing strip	—	<input checked="" type="checkbox"/>
insertable side blind	—	<input checked="" type="checkbox"/>
light and wind sensor	—	<input checked="" type="checkbox"/>
valance	—	<input checked="" type="checkbox"/>
infrared heater	—	<input checked="" type="checkbox"/>
vibrabox / radio control light sensor Sunis WireFree	—	<input checked="" type="checkbox"/>

#### Covers

	fabric range no.	standard	optional
sunsilk snc	324 .. / 328 .. / 369 ..	<input checked="" type="checkbox"/>	—
sunsilk perla FR	374 ..	—	<input checked="" type="checkbox"/>
sunvas snc	310 .. / 311 .. 313 .. — 315 ..	<input checked="" type="checkbox"/>	—
sunvas perla	370 ..	—	<input checked="" type="checkbox"/>

= motor
 = manual operation
 **M** = awning width









= no. of folding arms
 = no. of bespoke arms
 **M min.** = minimum widths

= no. of rolltex bearings
 **H** = projection

**Dimensions and tolerances**

	width	projection
housing tolerances	+ 5 / - 5 mm	± 40 mm
awning cover width = awning width	- 170 mm	
awning cover length = awning projection		+ 150 mm

**Frame colours**

		standard	optional
traffic white	RAL 9016		
metallic aluminium	RAL 9006		
grey brown, similar to	RAL 8019		
light ivory	RAL 1015		
anthracite metallic	5204		
stone grey metallic	5215		
off-white textured finish	5233		
Havana brown textured finish	5229		
non-standard powder-coated finish			

**Additional Information**

The width of the awning cover is always **less** than that of the awning. Please refer cover sizes in the case of coupled units and those with more than 2 arms to us.

**Pitch adjustment range:**

from 5° to 45° (to the horizontal).

**Definition of projection:**

Please consult the section “Technical Information”.

In the case of manual operation approximately **16 winding handle revolutions can be assumed per metre of awning projection.**

It takes approximately **12 seconds per metre** to extend a **motor-driven awning.**

**Coupled folding-arm awnings** are available up to a **max. of 3 single units** side by side, however only with a maximum of 6 folding-arms and **only operated by motor.**

A coupled unit is available with **junction roller**. Pattern repeat mismatches are possible in the case of junction roller covers. A junction roller may not fit when the projection is the maximum for the width of each awning. (see also the section on “Installation”, the arm separation table).

If coupled blinds are fitted into a **recess or reveal** the overall width of the coupled awning must be at least 6 cm less than the width of the opening to allow the awning to be coupled.

Colours similar to those in the RAL chart. Colours may differ slightly from those depicted in both hue and finish.

01  
02  
03  
04  
05  
**06**  
07  
08  
09  
10  
11  
12  
13  
14  
15  
16  
17  
18  
19  
20  
21  
22  
23

## Fixtures, fittings and accessories

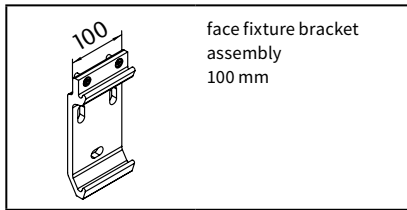

face fixture bracket assembly  
100 mm

71994.

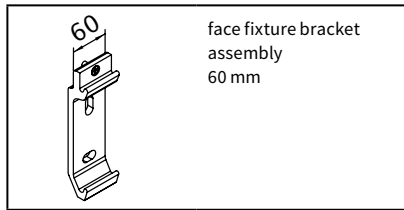

face fixture bracket assembly  
60 mm

71995.

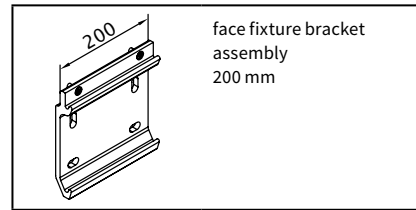

face fixture bracket assembly  
200 mm

71996.

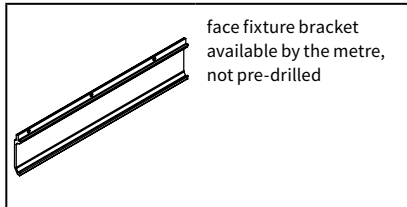

face fixture bracket available by the metre,  
not pre-drilled

71997.

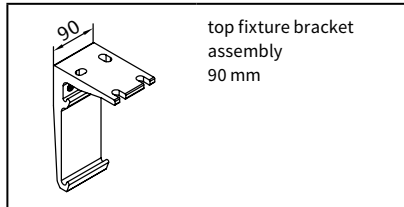

top fixture bracket assembly  
90 mm

71651.

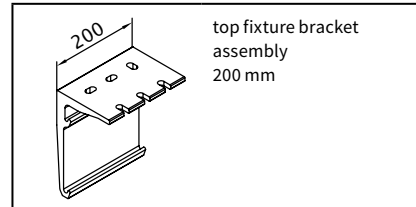

top fixture bracket assembly  
200 mm

71652.

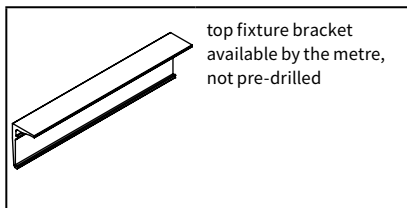

top fixture bracket available by the metre,  
not pre-drilled

73470.

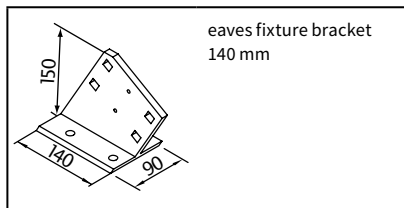

eaves fixture bracket  
140 mm

71612.

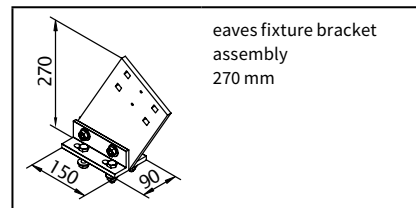

eaves fixture bracket assembly  
270 mm

71659.

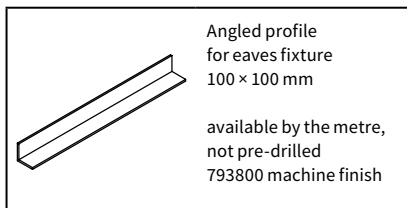

Angled profile for eaves fixture  
100 x 100 mm  
  
available by the metre,  
not pre-drilled  
793800 machine finish

79380.

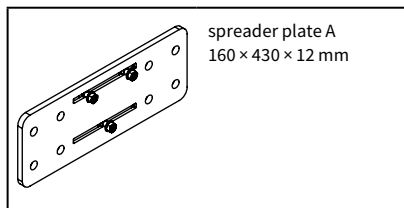

spreader plate A  
160 x 430 x 12 mm

75324.

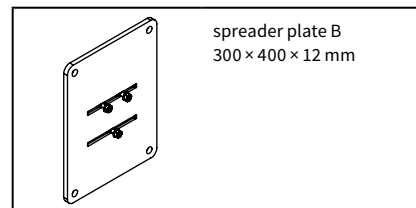

spreader plate B  
300 x 400 x 12 mm

75323.

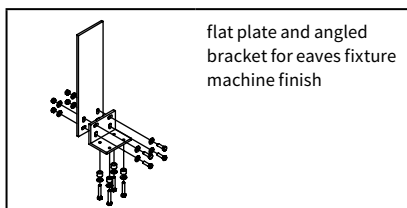

flat plate and angled bracket for eaves fixture  
machine finish

716620

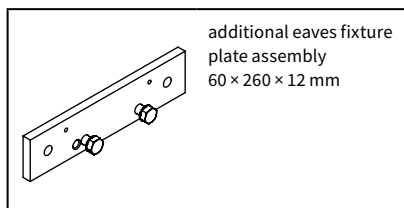

additional eaves fixture plate assembly  
60 x 260 x 12 mm

75383.

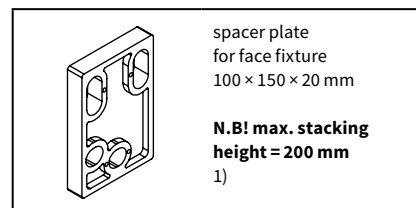

spacer plate for face fixture  
100 x 150 x 20 mm  
  
**N.B! max. stacking height = 200 mm**  
1)

718231

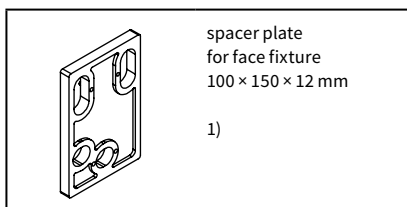

spacer plate for face fixture  
100 x 150 x 12 mm  
  
1)

718241

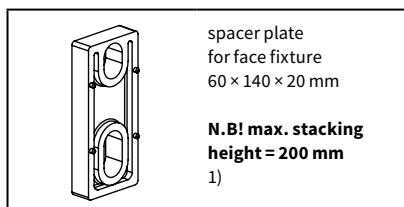

spacer plate for face fixture  
60 x 140 x 20 mm  
  
**N.B! max. stacking height = 200 mm**  
1)

716321

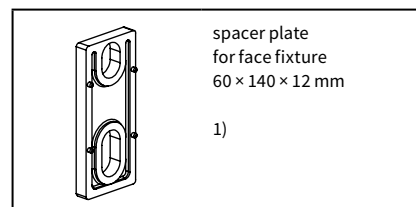

spacer plate for face fixture  
60 x 140 x 12 mm  
  
1)

71642.

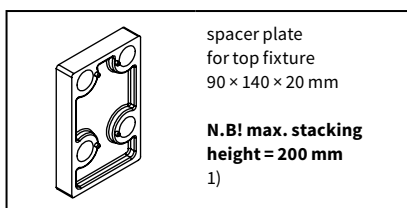

spacer plate for top fixture  
90 x 140 x 20 mm  
  
**N.B! max. stacking height = 200 mm**  
1)

716311

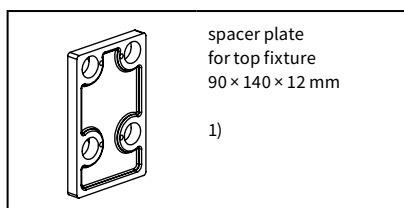

spacer plate for top fixture  
90 x 140 x 12 mm  
  
1)

716411

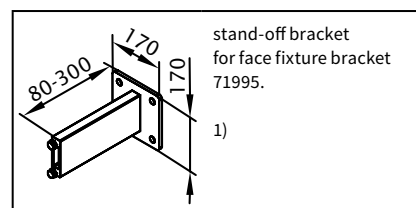

stand-off bracket for face fixture bracket  
71995.

77967.

1) please refer to the section „Technical Information“

. = insert RAL colour code no

### Fixtures, fittings and accessories

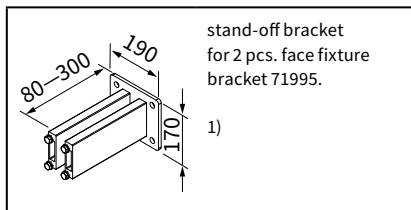

**77968.**

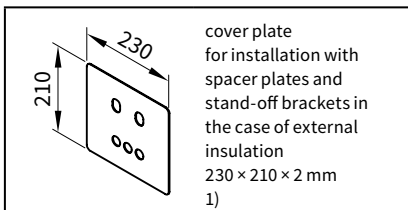

**71843.**

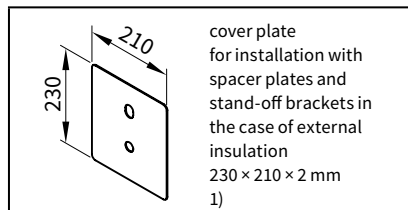

**71844.**

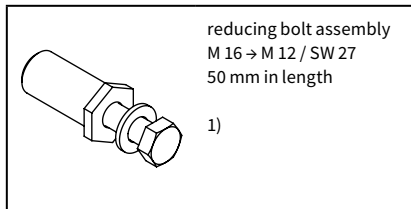

**753891.**

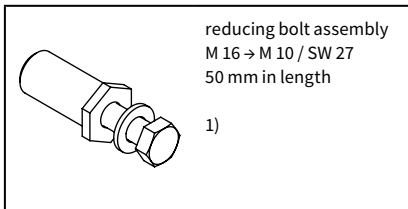

**754921**

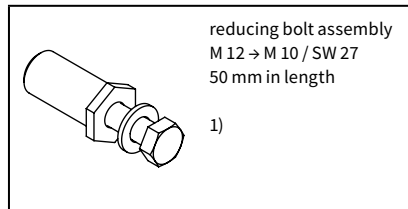

**754911**

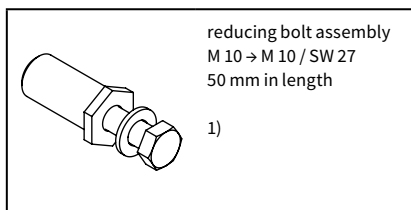

**754901**

1) please refer to the section „Technical Information“

- 01
- 02
- 03
- 04
- 05
- 06**
- 07
- 08
- 09
- 10
- 11
- 12
- 13
- 14
- 15
- 16
- 17
- 18
- 19
- 20
- 21
- 22
- 23

. = insert RAL colour code no

### Face fixture

Pull-out force [N=Newton] per upper fixing point according to EN 13561, wind resistance class 2

**Compression-proof substrate**

**Non compression-proof substrate**

		M [cm]									M [cm]										
		250	300	350	400	450	500	550	600	650	700	250	300	350	400	450	500	550	600	650	700
H [cm]	FB [N]																				
150		653	755	857	958	1060	1162	1263	1365	1467	1031	689	797	904	1011	1119	1226	1333	1441	1548	1089
200		996	1152	1308	1464	1620	1776	1932	2088	2244	1795	1051	1216	1381	1545	1710	1875	2040	2204	2369	1894
250		—	1677	1897	2118	2338	2559	2779	3000	3585	3095	—	1770	2003	2235	2468	2701	2934	3167	3785	3267
300		—	—	2526	2822	3117	3412	4150	4487	4824	4302	—	—	2667	2978	3290	3602	4381	4736	5092	4540
350		—	—	—	3620	4000	4926	5363	5799	5368	5697	—	—	—	3821	4222	5200	5661	6122	5666	6014

HT   BHT	2   100 mm		2   100 mm	2   100 mm	3   100 mm	2   100 mm		2   100 mm	2   100 mm	3   100 mm
BM	6		10	12	15	6		10	12	15

HT   BHT	2   200 mm				3   200 mm	2   200 mm				3   200 mm
BM	8				14	8				14

The pull-out force refers to the vertical centre to centre measurement between the fixture points of **90 mm**. If this measurement is reduced to the minimum, the pull-out force increases by **18%** in the case of **compression-proof substrates** and by **19%** in the case of **non compression-proof substrates**.

- M = awning width
- H = projection
- FB = pull-out force per fixing point
- HT | BHT = bracket quantity | width
- BM = no. of fixing points
- WA = wall seal by way of aluminium profile with rubber sealing strip
- 71995. = face fixture bracket assembly 60 mm
- 71994. = face fixture bracket assembly 100 mm
- 71996. = face fixture bracket assembly 200 mm

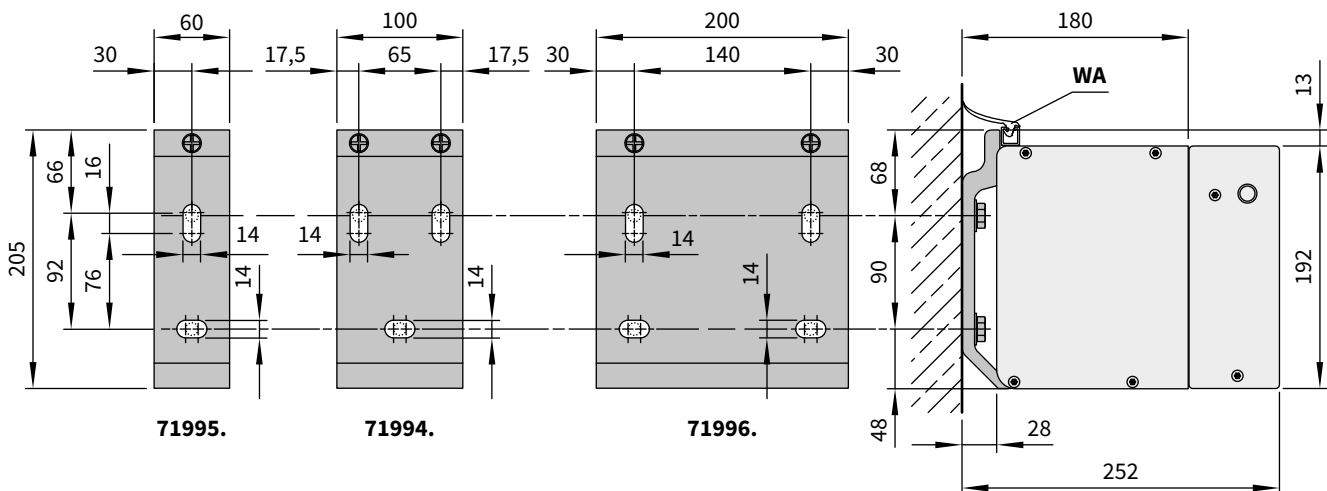

dimensions in mm



# Face fixture with spreader plate A

Pull-out force [N=Newton] per upper fixing point according to EN 13561, wind resistance class 2

**Compression-proof** substrate  
M [cm]

H [cm]	FB [N]									
	250	300	350	400	450	500	550	600	650	700
150	290	336	381	426	471	517	562	607	652	437
200	442	511	580	649	719	788	857	926	996	758
250	—	743	840	938	1036	1134	1231	1329	1589	1305
300	—	—	1118	1249	1379	1510	1837	1986	2135	1814
350	—	—	—	1600	1769	2179	2372	2565	2256	2402

**Non compression-proof** substrate  
M [cm]

H [cm]	FB [N]									
	250	300	350	400	450	500	550	600	650	700
150	413	477	541	606	670	734	798	863	927	621
200	628	726	825	923	1021	1120	1218	1317	1415	1078
250	—	1055	1194	1333	1472	1611	1750	1889	2258	1854
300	—	—	1589	1774	1960	2146	2610	2822	3034	2577
350	—	—	—	2274	2513	3096	3370	3645	3206	3414

HT   BHT	2   100 mm	2   100 mm 2   60 mm	2   100 mm 3   60 mm	3   100 mm 3   60 mm
BP	2	2	2	3
DP	—	2	3	3
BM	16	20	22	30

HT   BHT	2   100 mm	2   100 mm 2   60 mm	2   100 mm 3   60 mm	3   100 mm 3   60 mm
BP	2	2	2	3
DP	—	2	3	3
BM	16	20	22	30

HT   BHT	3   100 mm 1   60 mm
BP	3
DP	1
BM	26

HT   BHT	3   100 mm 1   60 mm
BP	3
DP	1
BM	26

The pull-out force refers to the vertical centre to centre measurement between the fixing points of **76 mm**. In the case of spreader plates a washer conforming to DIN 9021 must be used.

- M = awning width
- H = projection
- FB = pull-out force per fixing point
- HT | BHT = bracket quantity | width
- BP = no. of spreader plates
- DP = no. of spacer plates
- BM = no. of fixing points
- WA = wall seal by way of aluminium + rubber sealing strip

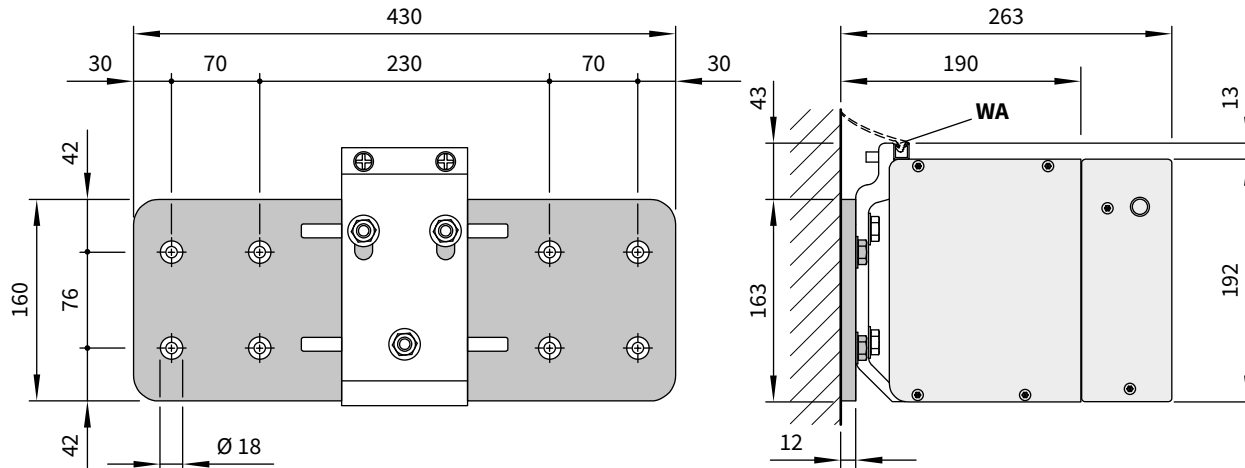

dimensions in mm

# Face fixture with spreader plate B

Pull-out force [N=Newton] per upper fixing point according to EN 13561, wind resistance class 2

**Compression-proof** substrate  
M [cm]

250	300	350	400	450	500	550	600	650	700
-----	-----	-----	-----	-----	-----	-----	-----	-----	-----

H [cm]	FB [N]									
150	86	99	113	126	139	153	166	180	193	129
200	131	151	172	192	213	233	254	274	295	224
250	—	220	249	278	306	335	364	393	470	386
300	—	—	331	369	408	447	544	588	632	537
350	—	—	—	474	523	645	702	759	668	711

**Non compression-proof** substrate  
M [cm]

250	300	350	400	450	500	550	600	650	700
-----	-----	-----	-----	-----	-----	-----	-----	-----	-----

H [cm]	FB [N]									
90	104	118	131	145	159	173	187	201	135	
136	158	179	200	222	243	265	286	307	234	
—	229	259	289	320	350	380	410	490	403	
—	—	345	385	426	466	567	613	659	560	
—	—	—	494	546	672	732	791	696	741	

HT   BHT	2   100 mm	2   100 mm 2   60 mm	2   100 mm 3   60 mm	3   100 mm 3   60 mm
BP	2	2	2	3
DP	—	2	3	3
BM	8	12	14	18

HT   BHT	2   100 mm	2   100 mm 2   60 mm	2   100 mm 3   60 mm	3   100 mm 3   60 mm
BP	2	2	2	3
DP	—	2	3	3
BM	8	12	14	18

HT   BHT	3   100 mm 1   60 mm
BP	3
DP	1
BM	14

HT   BHT	3   100 mm 1   60 mm
BP	3
DP	1
BM	14

The pull-out force refers to the vertical centre to centre measurement between the fixing points of **350 mm**. In the case of spreader plates a washer conforming to DIN 9021 must be used.

- M = awning width
- H = projection
- FB = pull-out force per fixing point
- HT | BHT = bracket quantity | width
- BP = no. of spreader plates
- DP = no. of spacer plates
- BM = no. of fixing points
- WA = wall seal using aluminium / rubber sealing strip

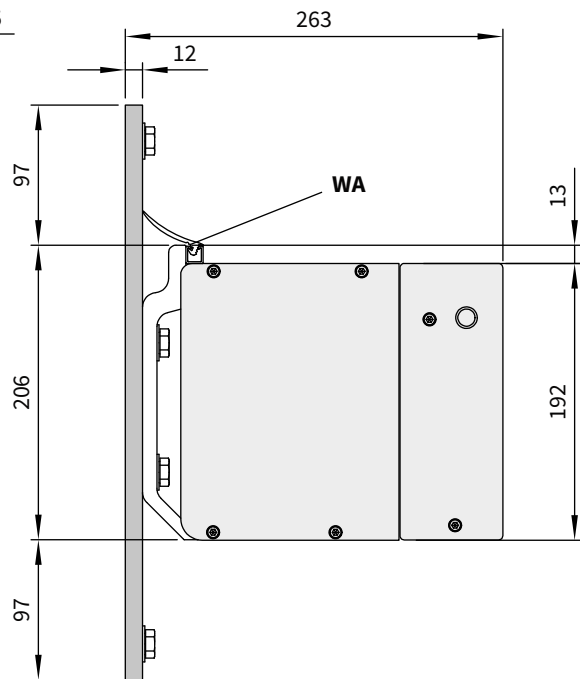
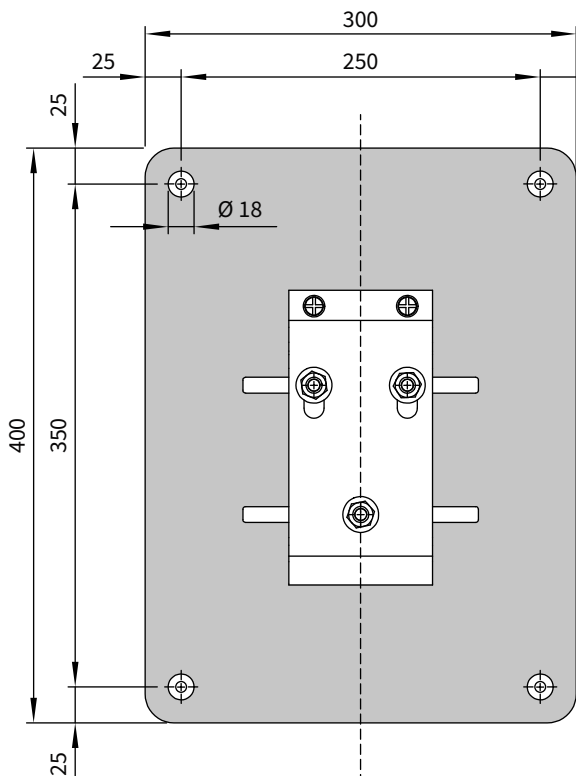

dimensions in mm

### Face fixture with stand-off brackets

Pull-out force [N=Newton] per upper fixing point according to EN 13561, wind resistance class 2

**Compression-proof** substrate  
M [cm]

H [cm]	FB [N]									
	250	300	350	400	450	500	550	600	650	700
150	596	688	779	871	962	1054	1145	1237	1328	889
200	864	998	1132	1266	1400	1534	1668	1802	1936	1474
250	—	1407	1591	1774	1958	2142	2326	2509	3009	2471
300	—	—	2069	2309	2550	2790	3403	3678	3954	3358
350	—	—	—	2910	3215	3968	4319	4670	4107	4373

**Non compression-proof** substrate  
M [cm]

H [cm]	FB [N]									
	250	300	350	400	450	500	550	600	650	700
150	671	774	877	980	1083	1186	1288	1391	1494	1000
200	972	1132	1274	1425	1575	1726	1877	2028	2178	1658
250	—	1583	1790	1996	2203	2410	2616	2823	3385	2780
300	—	—	2327	2598	2869	3139	3828	4138	4448	3779
350	—	—	—	3274	3617	4464	4859	5254	4620	4919

HT   BHT	2   100 mm	2   100 mm 2   60 mm	2   100 mm 3   60 mm	3   100 mm 3   60 mm
DH 77968.	2	2	2	3
DH 77967.	—	2	3	3
BM	8	16	20	24

HT   BHT	2   100 mm	2   100 mm 2   60 mm	2   100 mm 3   60 mm	3   100 mm 3   60 mm
DH 77968.	2	2	2	3
DH 77967.	—	2	3	3
BM	8	16	20	24

HT   BHT	3   100 mm 1   60 mm
DH 77968.	3
DH 77967.	1
BM	16

HT   BHT	3   100 mm 1   60 mm
DH 77968.	3
DH 77967.	1
BM	16

The pull-out force refers to the vertical centre to centre measurement between the fixing points of **120 mm**. In the case of stand-off brackets a washer conforming to DIN 9021 must be used.

- M = awning width
- H = projection
- FB = pull-out force per fixing point
- HT | BHT = bracket quantity | width
- BM = no. of fixing points
- DH = no. of stand-off brackets
- 77967. = stand-off bracket for face fixture bracket 71995.
- 77968. = stand-off bracket for 2 pcs. face fixture bracket 71995.

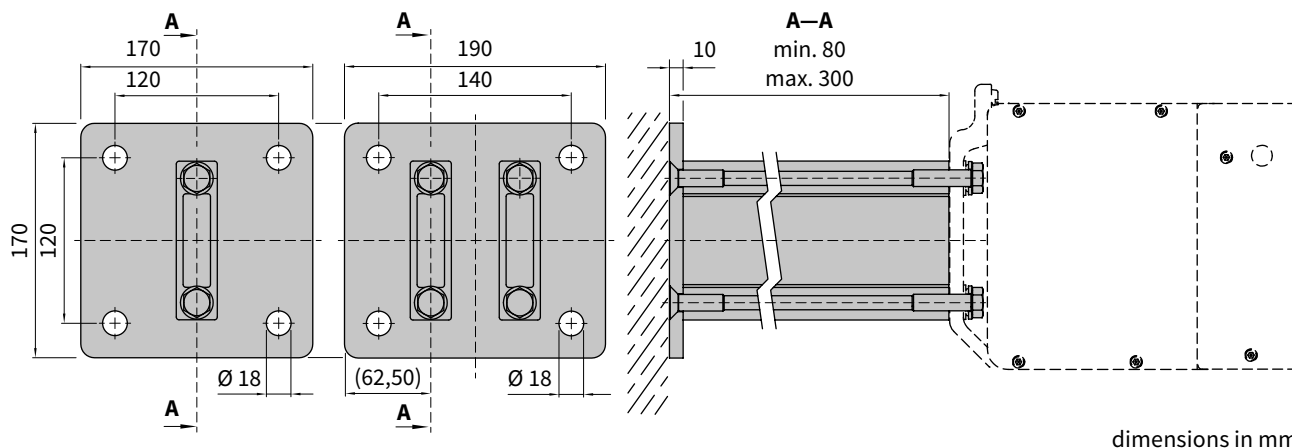
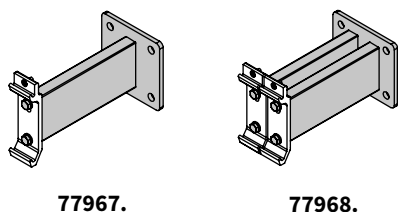

dimensions in mm

01  
02  
03  
04  
05  
**06**  
07  
08  
09  
10  
11  
12  
13  
14  
15  
16  
17  
18  
19  
20  
21  
22  
23

### Top fixture

Pull-out force [N=Newton] per upper fixing point according to EN 13561, wind resistance class 2

**compression-proof substrate**

**Non compression-proof substrate**

compression-proof substrate											Non compression-proof substrate													
M [cm]											M [cm]													
H [cm]											FB [N]													
250	300	350	400	450	500	550	600	650	700		250	300	350	400	450	500	550	600	650	700				
150	601	689	795	891	988	1084	1181	1277	1374	1027	837	971	1104	1237	1370	1504	1637	1770	1904	1399				
200	885	1026	1167	1309	1450	1592	1733	1875	2016	1657	1244	1442	1640	1838	2036	2233	2431	2629	2827	2305				
250	—	1459	1654	1849	2043	2238	2433	2627	3124	2731	—	2065	2339	2614	288	3162	3437	3711	4419	3849				
300	—	—	2173	2430	2686	2943	3565	3856	4146	3727	—	—	3086	3449	3812	4176	5065	5477	5889	5281				
350	—	—	—	3089	3415	4194	4567	4940	4596	4880	—	—	—	4396	4860	5974	6504	7035	6535	6938				
HT   BHT	2   90 mm			4   90 mm			5   90 mm			6   90 mm			2   90 mm			4   90 mm			5   90 mm			6   90 mm		
BM	8			16			20			24			8			16			20			24		
HT   BHT	2   200 mm								3   200 mm				2   200 mm								3   200 mm			
									1   90 mm												1   90 mm			
BM	12								22				12								22			

The pull-out force refers to the horizontal centre to centre measurement between the fixture points of **80 mm**.

- M = awning width
- H = projection
- FB = pull-out force per fixing point
- HT | BHT = bracket quantity | width
- BM = no. of fixing points
- 71651. = top fixture bracket assembly 90 mm
- 71652. = top fixture bracket assembly 200 mm

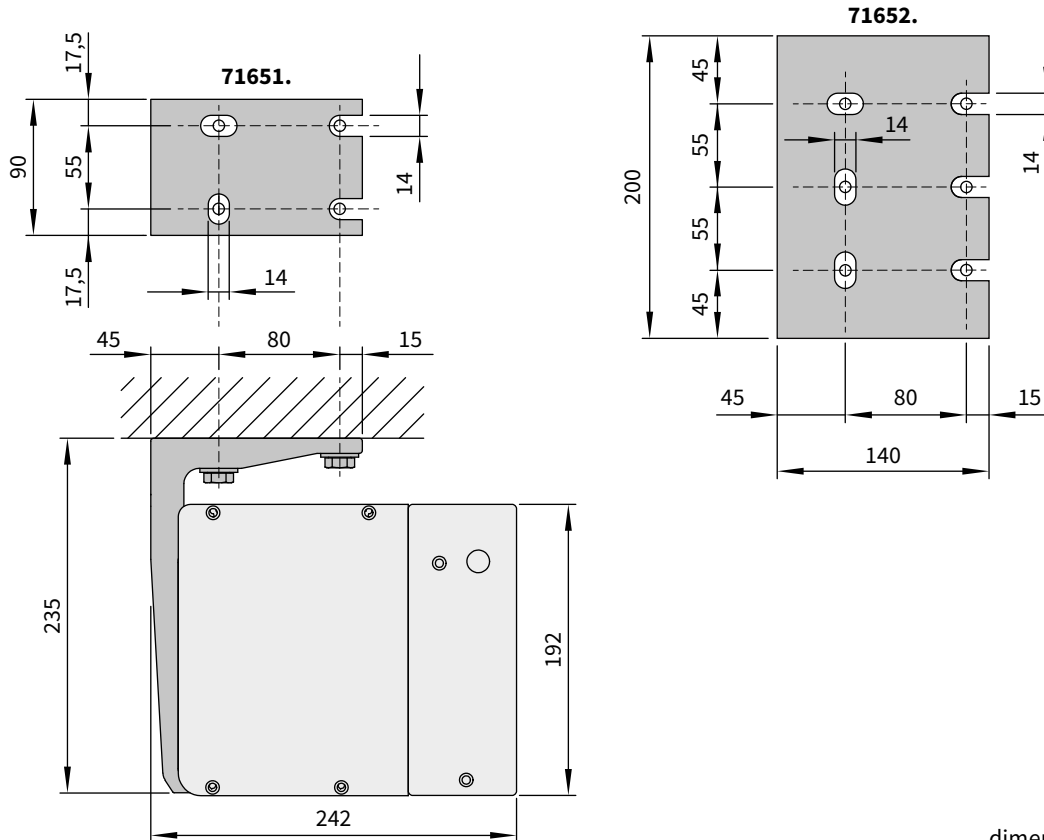

dimensions in mm

### Eaves fixture

Torque [Nm = Newton metres] for the fixture bracket next to the arm, shear force [N = Newton] per fixing point according to EN 13561, wind resistance class 2

Compression-proof substrate											Non compression-proof substrate										
M [cm]											M [cm]										
H [cm]											H [cm]										
FB [N]											FB [N]										
150	124	143	163	182	201	221	240	259	279	196	1502	1742	1982	2222	2461	2701	2941	3181	3420	2526	
200	189	219	248	278	308	337	367	397	426	341	2226	2580	2935	3289	3644	3998	4353	4707	5062	4137	
250	—	318	360	402	444	486	528	570	681	588	—	3687	4178	4669	5159	5650	6141	6631	7892	6882	
300	—	—	480	536	592	648	788	852	916	817	—	—	5506	6154	6803	7451	9035	9770	10506	9428	
350	—	—	—	687	760	936	1019	1102	1020	1082	—	—	—	7838	8666	10647	11594	12541	11654	12374	
HT	2			4			5		6		2			4			5		6		
BM	8			16			20		24		8			16			20		24		
HT	2								6		2								4		
BM	8								24		8								16		

The shear force is calculated on the basis of 2 fixing points per bracket, because – depending on the roof pitch – it cannot be guaranteed that 4 fixing points per bracket can be used.

- M = awning width
- H = projection
- Md = torque value for the bracket in the immediate vicinity of the arm
- HT = no. of brackets
- FS = shear force
- BM = no. of fixing points

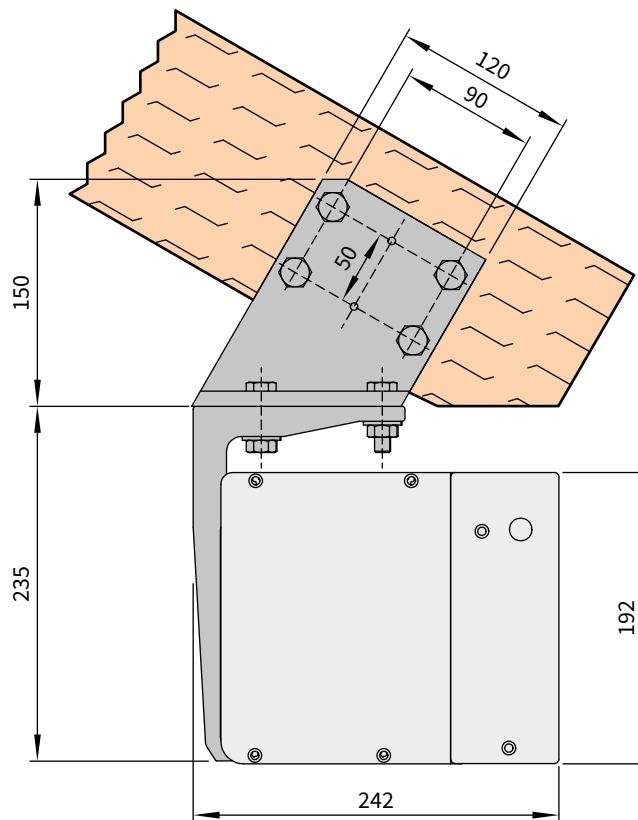

dimensions in mm

- 01
- 02
- 03
- 04
- 05
- 06
- 07
- 08
- 09
- 10
- 11
- 12
- 13
- 14
- 15
- 16
- 17
- 18
- 19
- 20
- 21
- 22
- 23

### Eaves fixture with additional spreader / backing plate

Torque [Nm = Newton metres] for the fixture bracket next to the arm, shear force [N = Newton] per fixing point according to EN 13561, wind resistance class 2

H [cm]	Torque M [cm]										Shear force M [cm]									
	250	300	350	400	450	500	550	600	650	700	250	300	350	400	450	500	550	600	650	700
	FB [N]										FB [N]									
150	124	143	163	182	201	221	240	259	279	196	745	866	988	1110	1231	1353	1475	1596	1718	1329
200	189	219	248	278	308	337	367	397	426	341	1070	1244	1417	1590	1763	1937	2110	2283	2456	2054
250	—	318	360	402	444	486	528	570	681	588	—	1742	1976	2211	2445	2680	2915	3149	3730	3289
300	—	—	480	536	592	648	788	852	916	817	—	—	2574	2879	3185	3490	4217	4562	4906	4435
350	—	—	—	687	760	936	1019	1102	1020	1082	—	—	—	3637	4023	4929	5369	5808	5423	5761
HT	2			4			5		6		2			4			5		6	
BM	8			8			10		24		8			8			10		24	
HT	2						4				2						4			
BM	4						8				4						8			

By using the additional spreader / backing plate, the shear force is reduced in comparison with conventional eaves fixture.

- M = awning width
- H = projection
- Md = torque value for the bracket in the immediate vicinity of the arm
- HT = no. of brackets
- FS = shear force
- BM = no. of fixing points

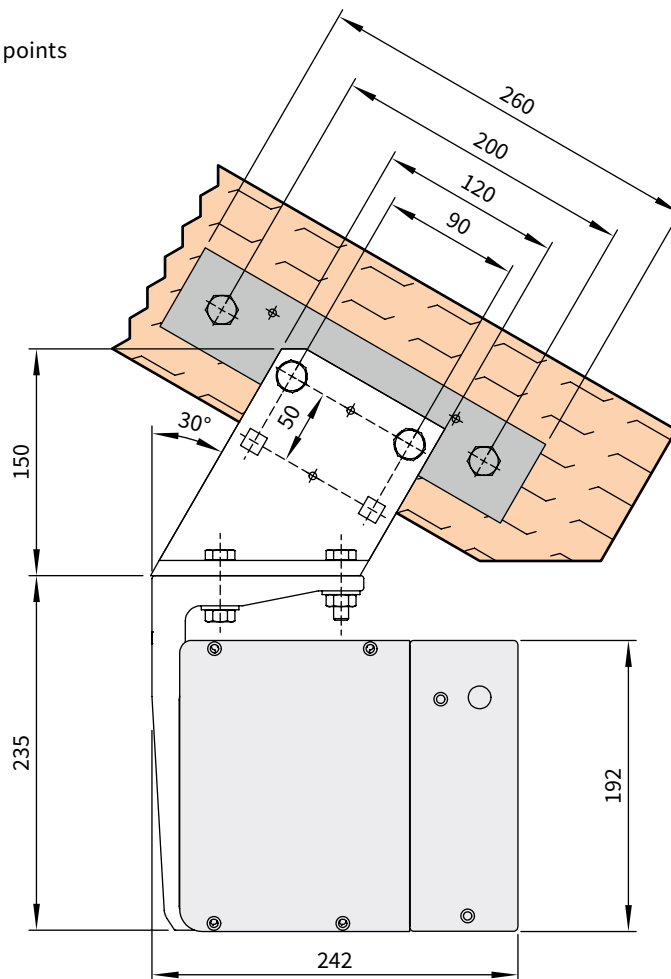

dimensions in mm

Recess fixture

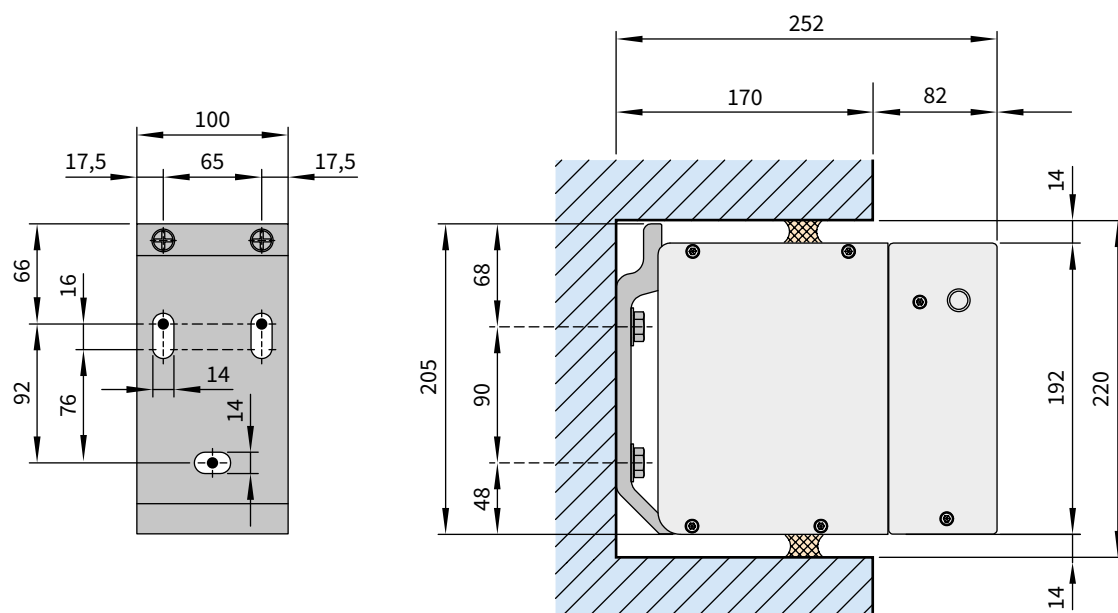

dimensions in mm

Cable exit position on motor-driven units

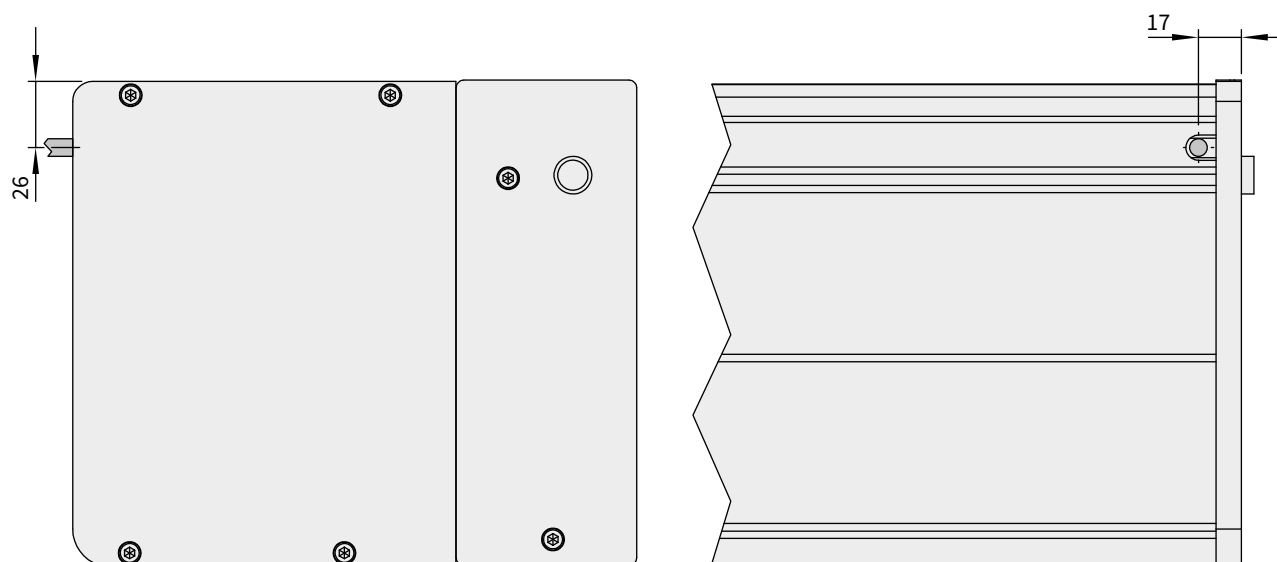

dimensions in mm

- 01
- 02
- 03
- 04
- 05
- 06
- 07
- 08
- 09
- 10
- 11
- 12
- 13
- 14
- 15
- 16
- 17
- 18
- 19
- 20
- 21
- 22
- 23

**Overview of the dimensions** (using face fixture with manual operation by way of example)

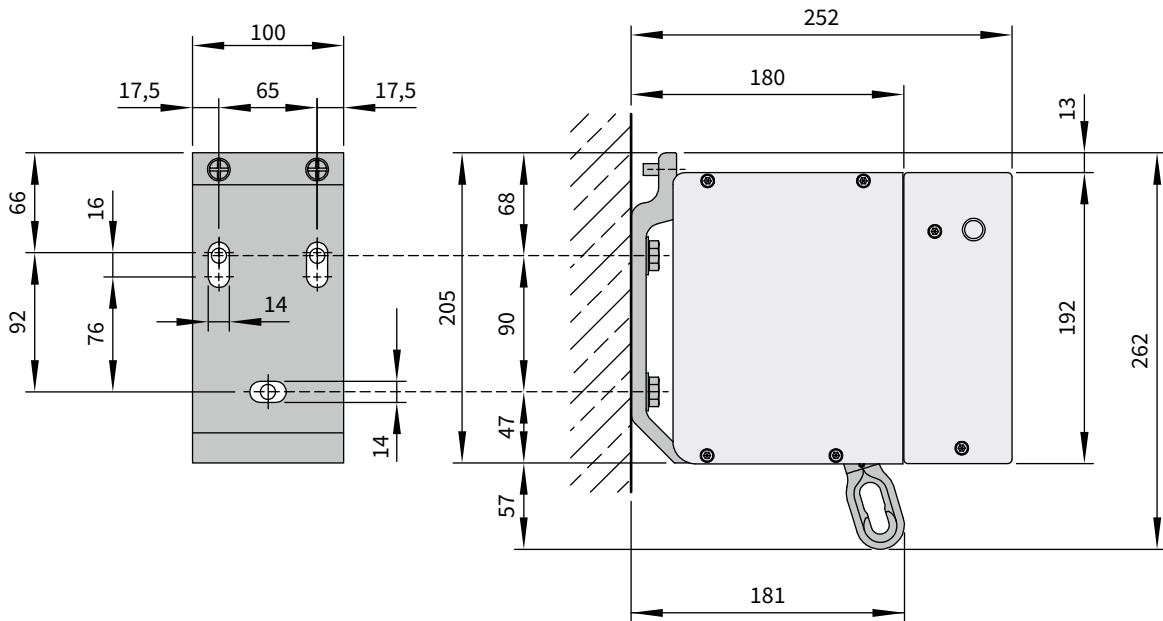

dimensions in mm

**Front view**

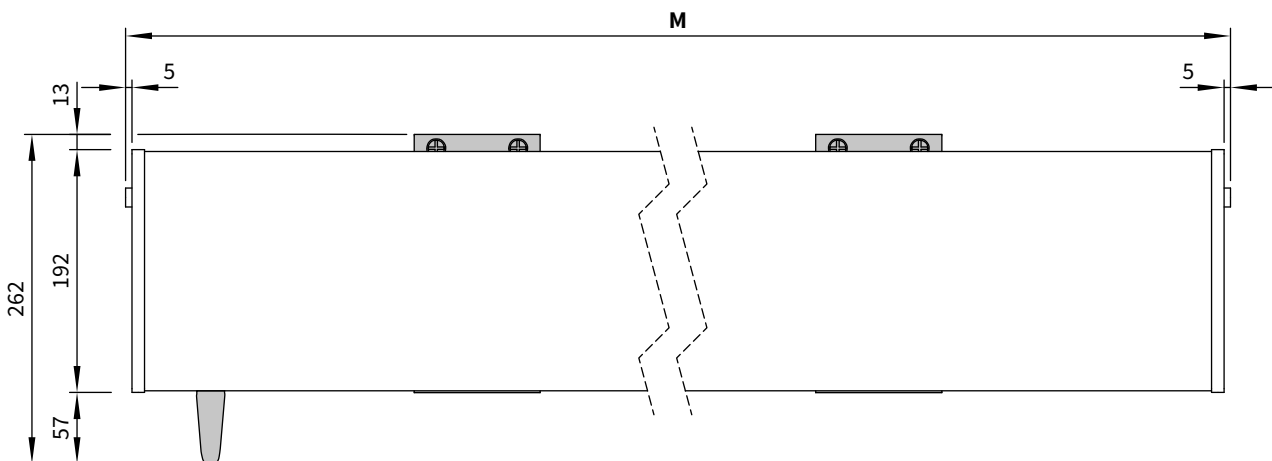

M = awning width

dimensions in mm



### Bracket fixture range for awnings with 2 folding arms

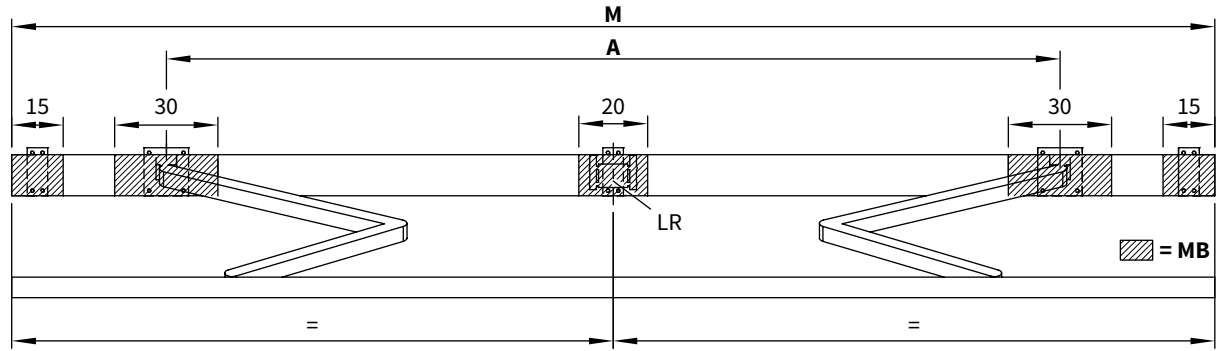

dimensions in cm

M [cm]	SB →	250	300	350	400	450	500	550	600	650
	ZB →	190–250	251–300	301–350	351–400	401–450	451–500	501–550	551–600	601–650

H [cm] ↓	A [cm]									
150	173**	230	260	300	340	380	410	450	490	
200	223*	230**	260	300	340	380	410	450	490	
250	—	273*	275**	300	340	380	410	450	490	
300	—	—	323*	325**	340	380	425	450	490	
350	—	—	—	373*	375**	380	440	450	—	

dimensions in cm

W	BHT ↓	HT ↓			
	60 mm	—	—	2	3
100 mm	2	—	2	2	
200 mm	—	2	—	—	

WA / B	60 mm	—	—	2	3
	100 mm	2	2	2	2

DE / DA	90 mm	2	—	4	5
	200 mm	—	2	—	—

If the brackets cannot be positioned in accordance with this table, make sure the actual measurements are noted on the order form!

- \* = Please note the minimum widths! Dimension **A** is only valid for standard arms! Dimension **A** is 13 cm smaller in the case of bespoke arms. Coupled units are not available with junction roller.
- \*\* = Coupled units are only available with junction roller in the standard widths, in the case of other widths please ask us.
- A = arm position
- BHT = bracket width
- DA = eaves fixture
- DE = top fixture
- H = projection
- HT = no. of brackets
- LR = a rolltex bearing with accompanying bracket is always placed under a central seam
- M = awning width
- MB = bracket fixture range
- SB = standard width
- W = face fixture
- ZB = intermediate width

01  
02  
03  
04  
05  
**06**  
07  
08  
09  
10  
11  
12  
13  
14  
15  
16  
17  
18  
19  
20  
21  
22  
23

### Bracket fixture range for awnings with 3 folding arms

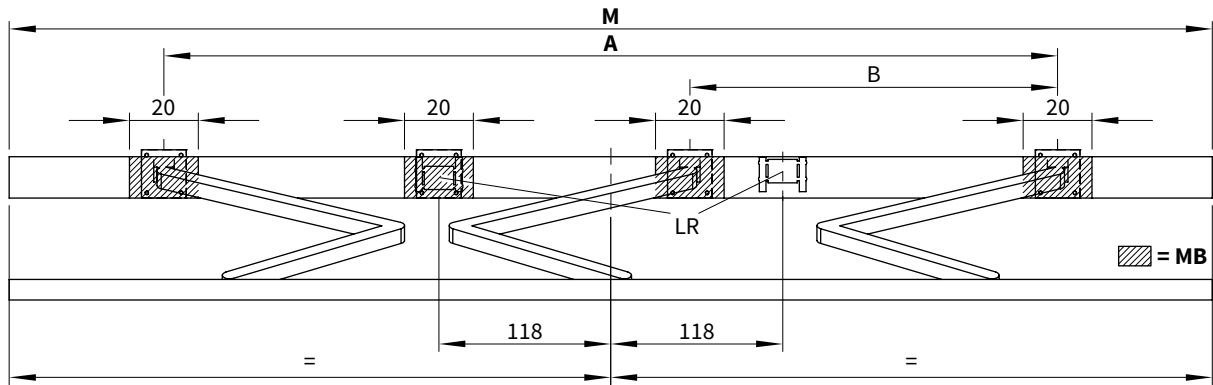

dimensions in cm

M [cm]	SB →	650	700		
	ZB →	—	651—700	651—694	695—700

H [cm] ↓	A [cm] ↓	B [cm] ↓	A [cm] ↓	B [cm] ↓	A [cm] ↓	B [cm] ↓	A [cm] ↓	B [cm] ↓	K [cm] ↓
150	—	—	540	250	—	—	—	—	450
200	—	—	540	250	—	—	—	—	500
250	—	—	550	235	—	—	—	—	550
300	—	—	580	235	—	—	—	—	600
350	620*	230*	—	—	621*	230*	625	230	650

dimensions in cm

W	BHT ↓	HT ↓	HT ↓
	60 mm	1	3
100 mm	—	3	
200 mm	3	—	

WA / B	BHT ↓	HT ↓
	60 mm	1
100 mm	3	3

DE / DA	BHT ↓	HT ↓
	90 mm	1
200 mm	3	—

If the brackets cannot be positioned in accordance with this table, make sure the actual measurements are noted on the order form!

- \* = coupled units are not available with junction roller
- A = arm position
- BHT = bracket width
- DA = eaves fixture
- DE = top fixture
- H = projection
- HT = no. of brackets
- LR = a rolltex bearing with accompanying bracket is always placed under a central seam
- M = awning width
- MB = bracket fixture range
- SB = standard width
- W = face fixture
- ZB = intermediate width